



The Sound Choice
for Leak Detection.™

User Guide: Pegasus 2 (Pressure control system)



Warning: This manual contains important safety and operating information. Please read, understand, and follow the instructions in the manual.

TABLE OF CONTENTS

1	System Documentation and Support of Product	5
1.1	Documentation and Technical support	5
1.2	Safety	5
1.3	Operating Temperature	5
1.4	Use of Cellular networks – Important Notes	6
1.5	Viewing Data.....	6
1.6	IDT – Software Tool (for device programming and tests).....	6
1.6.1	IDT (PC version).....	7
1.6.2	IDT app (mobile device version)	7
2	Overview	8
2.1	Introduction.....	8
2.2	Server integration option: DataGate and PressView Websites	11
2.3	Communications Interface and Programming Cables	11
2.4	Completing the communications path	12
2.4.1	IDT - used with a PC (& Windows).	12
2.4.2	IDT app - used with a Tablet (Android) / USB option.....	12
2.4.3	IDT app - used with a Mobile phone or Tablet / Bluetooth option.....	13
2.5	Pegasus 2 System Kits	14
2.6	External Battery (option)	14
2.7	Pegasus 2 Control Box – Description	14
2.7.1	Logger functions & Logging running state	15
2.7.2	PRV Control functions & running state	17
2.7.3	Controller Description	18
2.8	Solenoid Box - Description	20
2.9	Hydroswitch - Description.....	23
2.10	Mechanical Actuator	23
2.11	Summary of PRV Function (Pilot operated).....	24
2.11.1	Main valve	24
2.11.2	Pilot Valve operation	24
2.11.3	Pilot operated pressure reducing valve.....	25
2.12	PRV Function (under Pegasus 2 control)	26
2.12.1	Pegasus 2 Mechanical Actuator.....	26
2.12.2	Pegasus 2 System options: (Basic and “Latching” models)	26

2.12.3	Explanation of Latch Solenoid activation (High and Low unreachable).....	27
2.12.4	Theory of operation (Continuous pressure modulation).....	28
2.12.5	Theory of operation (Continuous pressure modulation + Latch).....	30
3	Configuration options (diagrams).....	36
3.1	Key to components within the diagrams.....	36
3.2	Standard installations: Continuous pressure control.....	39
3.2.1	Using: internal transducers (Pressure in < 90m)	39
3.2.2	Using: external transducers (Pressure in < 90m).....	40
3.2.3	Using: internal transducers (Pressure in > 90m)	41
3.2.4	Using external transducers (Pressure in > 90m).....	42
3.3	Standard Installation + High Pressure Unreachable.....	43
3.3.1	Using: Latch solenoid / internal transducers (Pressure in < 90m))	43
3.3.2	Using: Latch solenoid / external transducers (Pressure in > 90m).....	44
3.3.3	Using: Latch solenoid / internal transducers (Pressure in < 90m)	45
3.3.4	Using: Latch solenoid /external transducers (Pressure in > 90m).....	46
3.4	(Other Installation Options)	47
3.4.1	Models with additional Data Logging interfaces.....	47
3.4.2	Control of two PRVs.....	47
3.4.3	Configuration for timed supply / cut-off of water supply	47
4	Installation procedure (Pegasus2 / standard operation).....	48
4.1	Position Control and Solenoid boxes / Link with cable.	49
4.1.1	Antenna	49
4.1.2	Battery	49
4.1.3	Interconnection Cable	50
4.2	Connection to the Flow meter	50
4.3	Connect External Pressure transducers to Pegasus 2.....	51
4.4	Check / modify Pegasus2 channel settings.....	51
4.5	Re-zero Pressure transducers	53
4.6	Prepare the pipework for the Pegasus2	55
4.7	Prepare the PRV for Pegasus Pressure transducers.....	56
4.8	Connect Pegasus2 side pipework.....	57
4.9	Connect transducers and basic control pipework on PRV side	58
4.10	Bleed air from the pipework	58
4.11	Test Pressure transducers.....	60
4.12	Preparing to fit the actuator	61

4.13	Fitting and adjusting the HWM mechanical actuator	62
4.14	Latch Option - Prepare the PRV	65
4.15	Latch Option - Connect Latch pipework on Pegasus 2 side	66
4.16	Latch Option - Connect Latch pipework on PRV side	66
4.17	Latch Option – Re-instate Pilot Control / Bleed pipework	66
4.18	Latch option - Testing	67
4.19	Testing the Actuator (Manual Override).....	68
4.20	PRV Control method and Settings	69
4.20.1	Setup of pressure control using a Time profile.....	73
4.20.2	Setup of pressure control using a Flow profile	75
4.20.3	Setup of pressure control using a combined Time and Flow profile	79
4.21	Setup for annual time adjustments.....	80
4.22	Save Program & Activate PRV control.....	80
4.23	Setting Logger Startup / Measurement Sample Rates	81
4.24	Setup of Data Delivery	81
4.25	Antenna installation / Cellular Communications checks	82
4.25.1	Selection / Preparation / Initial Placement.....	82
4.25.2	Antenna / Communication checks	83
4.26	Verification of the configuration.	84
4.27	Protection from Frost.....	84
5	Installation (Non-standard / Latch on Low unreachable)	85
5.1	Modification of plumbing and operation.....	85
5.2	Modification of Latch settings and outcomes	86
5.3	Modification of Control method	86
6	Installations with parallel PRVs	87
7	Graphing / data download and preview.....	90
8	Connection Information	90
8.1.1	FLOW Meter connection / cable RAG 93.....	90
9	Maintenance, Service and Repair.....	91
9.1.1	Return of product for Investigation, Service. Or Repair:	91
9.1.2	Putting the equipment into Shipping Mode.....	92
9.2	Water ingress	94

1 SYSTEM DOCUMENTATION AND SUPPORT OF PRODUCT

1.1 DOCUMENTATION AND TECHNICAL SUPPORT

Thank-you for choosing a HWM device. We trust it will provide you with many years of service.

The Pegasus2 system is designed to control the outlet pressure from a clean-water pressure reducing valve.

This user-guide provides details of each component of the Pegasus2 system and also the system itself, (including alternative configuration options). It provides details of how to install the product in a stand-alone mode and also (optional) integration with the HWM DataGate system, providing on-line viewing of pressure measurements.

This user-guide covers the following models:

<u>Model Number(s)</u>	<u>Description</u>
C163C/*/*/*/*	Pegasus2 Controller unit
C163S/*/*	Pegasus2 Solenoid unit
C163F/*/*/*/*	A kit of individual units plus additional components to make a complete Pegasus2 system.

<u>Accessories</u>	<u>Description</u>
RCA7922L	Hydroswitch with solenoid.

Note: The part-number structure is also shared with the "Sentinel 2" family of models. Sentinel 2 has its own user-guide.

Note: The system periodically has new features and changes released, thus you may observe slight changes in layout from those shown in this manual. Additionally, views can vary depending on what user-role you have been given and its permissions.

HWM provides support of the Pegasus2 system by means of our customer support webpages: (Note: Customer registration is required to access).

<https://www.hwmglobal.com/help-and-downloads/>

Should you have any questions that are not covered by this manual or the system's online help, please contact the HWM Technical Support team on +44 (0) 1633 489479, or email cservice@hwm-water.com

1.2 SAFETY

Before continuing, please read the "Safety Warnings and Approvals Information" document supplied with the product.

WARNING: This equipment should be installed, adjusted, and serviced by qualified water industry maintenance personnel familiar with the construction and operation of the equipment and the hazards involved. Failure to observe this precaution could result in damage to the water network.

1.3 OPERATING TEMPERATURE

Refer to the Datasheet or your sales representative for guidance on the storage and operating temperature range of the device. Ensure the unit is within the operating temperature range prior to installation or setup.

1.4 USE OF CELLULAR NETWORKS – IMPORTANT NOTES

Availability of SMS

Most Pegasus2 models include the ability to communicate to a server via use of the cellular data network. This is usually via the regular data network (which gives internet access). Alternatively, the SMS (Short Message Service) messaging can be used; in most cases this will be as a fall-back if the logger is temporarily unable to access the regular data network. If configured for SMS use, the logger uses the available **2G network**.

Important: 2G (GPRS) services, which carry the SMS messaging system, are slowly being turned off around the globe. Once 2G is switched off, the SMS services available within the logger will no longer be able to function. Unless deactivated in the logger settings, the logger will continue to try, wasting battery power. Therefore, check with your cellular network operator for their switch off date before setting the logger to use the SMS backup service or any other feature requiring SMS use.

To deactivate the use of the SMS system, any related SMS settings must be removed (switched off or deleted). Refer to the IDT User Guide for details of SMS settings. Any modified settings must be saved to the logger.

Note: For use of SMS services, both the logger and the cellular network provider must support SMS. In addition, the SIM card fitted inside the logger must support SMS use. (Check with your SIM supplier if required).

Logger identity when using SMS

When using the cellular data network, the logger identity is included with the data within the message. However, when using the SMS system, the identity is the calling number (from the SIM card). Thus, when using any SMS services, these two numbers (IDT setting of logger telephone number and SIM telephone number) must match.

1.5 VIEWING DATA

To view Pegasus2 data **remotely**, a viewing tool (website) is used. Various websites are available.

- Pegasus2 is most frequently used with the PressView website, which is for use with pressure control applications.
- Data produced by the built-in logger can also be seen on the DataView website.

Data from the Pegasus2 unit can also be viewed **locally** using IDT during a site visit.

Refer to the training materials available for your viewing tool and also the IDT user-guide for further information.

1.6 IDT – SOFTWARE TOOL (FOR DEVICE PROGRAMMING AND TESTS)

A software tool, known as “IDT” (Installation and Diagnostic Tool), provides a user-interface to the Pegasus2. It can be used for checking or making adjustments to the setup of the unit, for assisting with installation of the system, and also for testing the operation of the unit within its installed site.

Choosing which version to use

Prior to IDT being able to perform its functions, it has to 'connect to' the Pegasus2; this simply means that the two end devices (Pegasus2 software and IDT software) are able to communicate with each other over a working communications path.

IDT is available in three versions:

- IDT for PCs having a Windows-operating system.
- IDT for mobile devices (phones and tablets) having an Android operating system.
- IDT for mobile devices (phones and tablets) having an (Apple) iOS system.

The latter two are referred to as the 'IDT app', whereas the first is referred to as 'IDT (PC)'

1.6.1 IDT (PC version)

Refer to the IDT (PC version) User-Guide (MAN-130-0017) for details of how to prepare your PC for communicating with the Pegasus2. The user-guide also gives details of how to use IDT for many settings, including those of the built-in logger; many of these are required for use by the PRV controller.

The functions exclusive to the PRV control aspects of Pegasus2 are covered in this user-guide.

1.6.2 IDT app (mobile device version)

Refer to the IDT app User-Guide (MAN-2000-0001) for details of how to prepare your mobile device for communicating with the Pegasus2. The user-guide also gives details of how to use IDT for many settings, including those of the built-in logger; many of these are required for use by the PRV controller.

The functions exclusive to the PRV control aspects of Pegasus2 are covered in this user-guide.

2 OVERVIEW

2.1 INTRODUCTION

Pegasus2 is a system that is used to control the outlet pressure of a pressure reducing valve (PRV) within a clean-water supply pipe network. The Pegasus2 includes built-in data logger functionality. This section gives an overview of Pegasus2, the equipment that is required to use it, and other (optional) system elements.

The system is designed to control pressure reducing valves that are designed and manufactured by 3rd party suppliers. Therefore, only general details of PRV valve construction are included in this manual.

Pressure control can be either:

- Continuous control:
i.e. Incremental adjustment of pressure, between a maximum and minimum;
The Pegasus2 product is ideal for this situation.
or
- 2-point control:
i.e. Automatic switching between two pre-set pressure levels.
The Sentinel 2 product is ideal for this situation.
... It is a simplified product, based on the Pegasus2.
It does not use the Solenoid Box; a Hydroswitch unit is used. (Refer to the Sentinel 2 manual for further details).

Pegasus2 allows incremental adjustment of the PRV output pressure to closely follow a pre-determined pressure profile.

The pressure profile can be based on:

- The time of day, or
- The flow rate (demand) of water, or
- Both of the above.

The pressure profiles are defined by a set of tables within the unit. The tables can be entered manually during installation. Pegasus2 can also communicate with a central server that is used to store its measurement data. The server can be configured to analyse the effectiveness of the Pegasus2 pressure control and (if required) remotely update the unit's pressure profiles. (This is achieved via PressView web software).

The system also offers a fail-safe mode, where it can operate the PRV at a fixed outlet pressure when certain fault conditions occur (e.g., detection of a sensor failure).

The Pegasus2 system typically consists of the following parts:

- A Control Box unit.
- A Solenoid Box unit.
- A cable linking the Control Box to the Solenoid Box.
- A HWM mechanical actuator.

- An accessory kit for plumbing-in the Pegasus2 system to work with the PRV. (HWM can supply standard kits containing colored plastic tubing, a 3-way manual valve, quick-connect fittings).
- Hanging brackets.
- Cables for sensors (transducers or meters).
- An antenna for communication over the mobile cellular network (For optional server integration).
- (Optional / If required) External battery.
- A USB Communications cable (an accessory required for on-site installation, programming, and data retrieval).

The system contains transducers for measurement of water pressure. These may be built-in (for connection to the system via water pipes) or (where external transducers employed for direct connection) attached via cables.

Caution: (Pegasus 2 compatibility with Pegasus Plus)

The Pegasus2 system REPLACES previous generations of HWM pressure control systems, known as Pegasus and Pegasus Plus.

Pegasus2 control box and solenoid box units are not compatible with Pegasus or Pegasus Plus units; the units cannot be used inter-changeably or mixed.

The Pegasus2 (complete system) can replace a Pegasus or Pegasus Plus (complete system), depending on the model numbers and settings of the units.

Existing sensors and pipework may be compatible, and may be re-used with a Pegasus2 installation if in good condition.

The cable between the Control Box and Solenoid box is incompatible between old systems and Pegasus2.

The Pegasus Plus USB Communications cable is also compatible with Pegasus2.

The Pegasus2 system controls the PRV by means of hydraulic actuation. It therefore contains several solenoid valves which are controlled by the unit. These require connection to various points in the water supply and PRV.

An example of a PRV with Pegasus2 system installed is shown opposite.

Several configuration alternatives exist, depending on the required system behavior.

The model number of each unit must be selected to match the requirements of the installation.

In addition, the standard configurations must not be used in high pressure situations (>90 meters) to prevent damage to the system components. An alternative system configuration (plumbing scheme) must be used.

An example of the standard installation accessory kit, plus the actuator, and brackets are shown above and opposite.

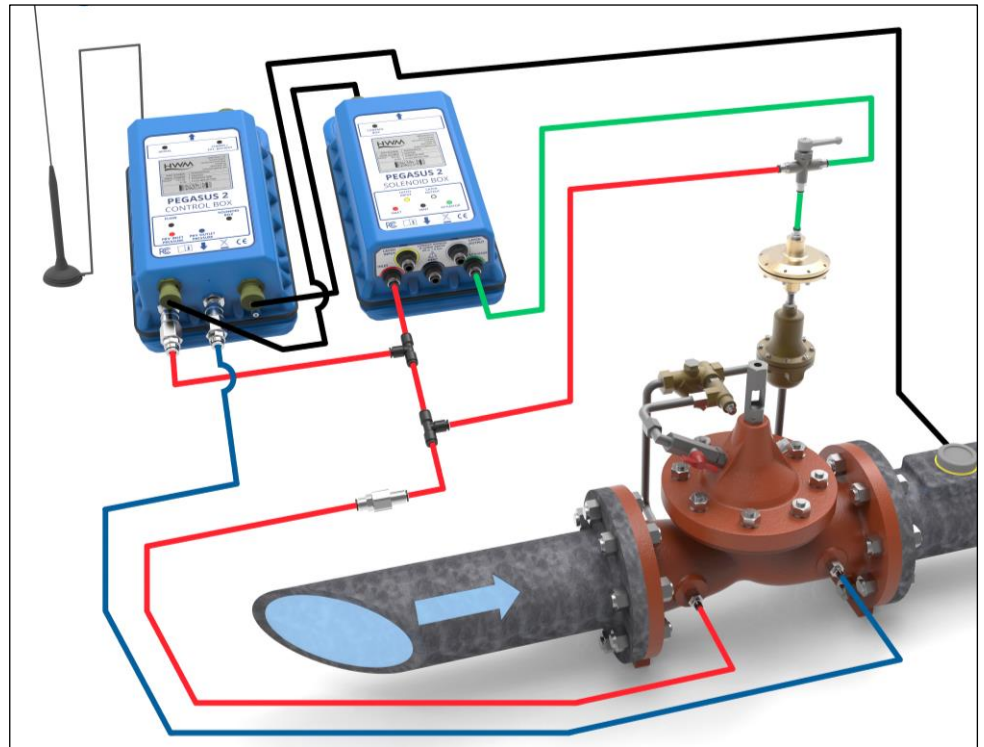

2.2 SERVER INTEGRATION OPTION: DATAGATE AND PRESSVIEW WEBSITES

When integrated with HWM's DataGate server, the Pegasus measurement data can be stored on the server every time the unit makes a call-in.

The data can be viewed remotely / graphically by anyone with a suitable user account (and password) using a standard web-browser. The data is viewed in PressView.

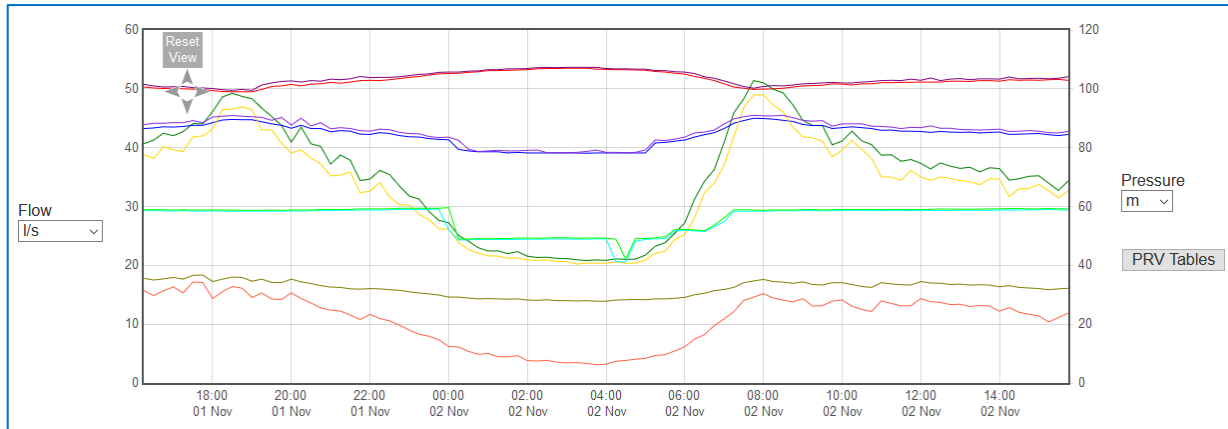

The PressView website allows the Pegasus2 data to be combined with pressure measurements made (by another HWM logger device) some distance down-stream of the PRV (e.g. at a “critical point”). Both the local and remote measurements can be assessed by the server, and (whenever an adjustment is needed) revised pressure profiles sent to the Pegasus2 unit. PressView supports both “Learning” and “Active” (closed loop) modes of operation. These features are not covered further in this document; refer to the User-Guide for PressView for more details.

The Pegasus2 can also send any fault notifications (alarms) to the server for forwarding to interested parties.

2.3 COMMUNICATIONS INTERFACE AND PROGRAMMING CABLES

To communicate with the Pegasus2, a programming cable is required, which connects to the COMMS interface on Control Box.

The COMMS interface connector and a communications cable are shown below.



The connector used for communications also include the connections required for fitting an external battery (see section 2.6). The connector of the communications cable will only include the pins required for communications purposes. To use the communications cable, temporarily remove any existing connector, and re-connect it when finished. Alternatively, an adaptor (Y-cable) can be temporarily inserted to be able to support using both Communications and External Battery functions together.

Attach the Comms cable to the logger, and then complete the connection to the IDT host using one of the methods described in section 2.4.

Examples of suitable programming cables are given below:

- COM AEUSB (USB to RS232 comms cable).
- CABA2075 (direct USB comms cable).

2.4 COMPLETING THE COMMUNICATIONS PATH

Select an appropriate cable and connect it to the COMMS connector of the Pegasus2, as described in section 2.3. The USB-A end of the programming cable should be used to connect to the IDT host by using one of the following methods:

2.4.1 IDT - used with a PC (& Windows).

Prior to use, the PC should have the IDT (PC version) programming tool installed.

The USB-A end should be plugged directly into a USB-A port of the PC (or to USB-B or USB-C port via a suitable adaptor). Refer to the diagram below.

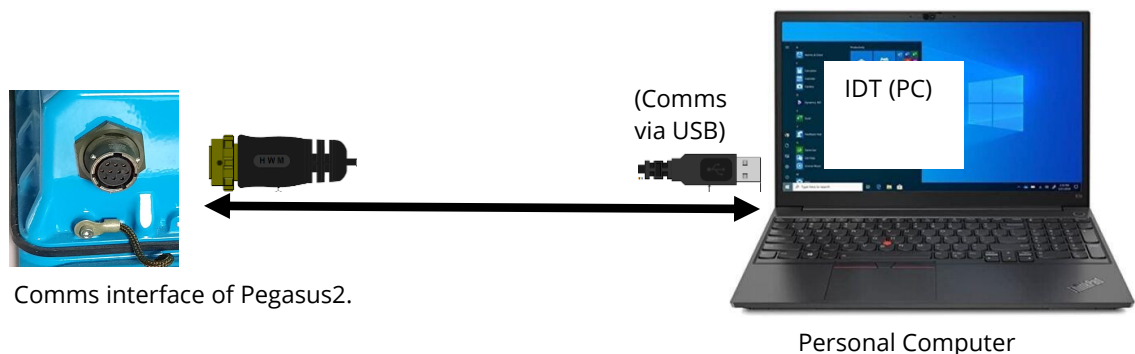

2.4.2 IDT app - used with a Tablet (Android) / USB option

Certain Android-based Tablet devices (which must have an available USB port) are able to use this method. (For known compatible devices, contact your HWM representative).

Prior to use, the mobile device should have the IDT app software installed.

The USB-A end should be plugged directly into a USB-A port of the tablet (or to a USB-B or USB-C port via a suitable adaptor). Refer to the diagram below.

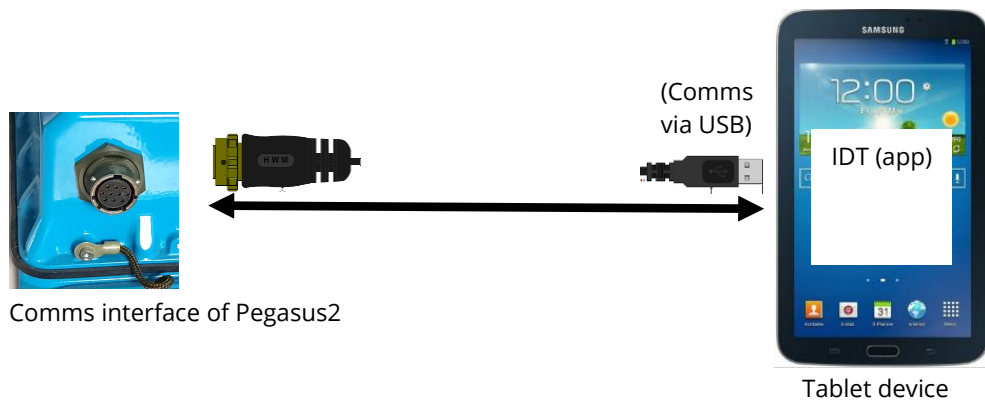

This connection method is only compatible with the COM AEUSEB (USB to RS232) comms cable.

2.4.3 IDT app - used with a Mobile phone or Tablet / Bluetooth option

Certain mobile phone or tablet devices (which must be Android or iOS-based and support Bluetooth radio) are able to use this method.

Prior to use, the mobile device should have the IDT app software installed.

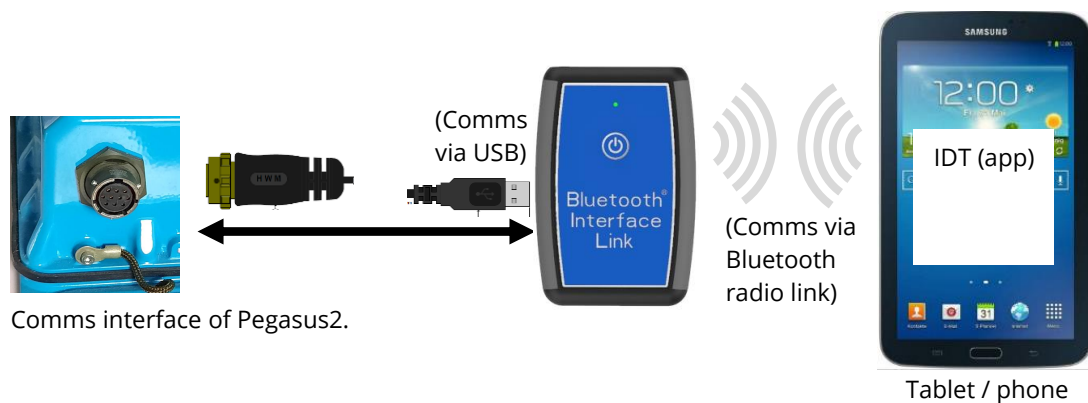

The connection path (refer to the diagram above) makes use of a communications adapter known as the HWM 'Bluetooth Interface Link'.

Connect the Pegasus2 end of the communications cable to the COMMS connector. Then the USB-A end of the cable should be plugged into the USB-A port of the Bluetooth Interface Link unit. The device should be turned on during use.

The IDT app is required to be paired to the Bluetooth Interface Link unit prior to communication with Pegasus2.

The Bluetooth Interface Link handles protocol translations and flow control of messages between the Pegasus2 (via the comms cable) and the radio link.

2.5 PEGASUS 2 SYSTEM KITS

Pegasus2 **systems** can be ordered using a system **kit part-number**.

A kit part-number is used merely for the purpose of ordering several system components under a single part-number. No components will be labeled with the kit part number; Each item will be labeled using its regular part-number (as described within sections that follow).

Please discuss any requirements for ordering Pegasus2 as a system kit with your sales representative.

2.6 EXTERNAL BATTERY (OPTION)

The system operates from internal batteries or (optional) using an additional external HWM battery unit (see an example opposite).

Where supplied, the external battery power is used to extend the battery life of the system or for more frequent communications with the host server.

The battery connection has to be removed whenever the communications cable is fitted; they share the same connector. Be sure to re-connect the battery prior to leaving the unit.

Always use HWM supplied batteries to ensure compatibility and safety.

(For situations where the use of an external battery is required, seek the advice of your HWM representative).



2.7 PEGASUS 2 CONTROL BOX – DESCRIPTION

Pegasus2 control box is a combination of a PRV controller and a built-in data-logger.

The unit is shipped from the factory in a low-power mode referred to as “Shipping mode”. The **logging functions** have to be activated (see section 2.7.1) at an appropriate time during installation (see section 4.26).

Similarly, the unit is shipped from the factory with the **PRV Control function** in an inactive ('No Control') state. The PRV Control function should be made active (see section 2.7.2) at an appropriate point during installation (see section 4.26).

Although both controllers (logger and PRV) can be started or stopped independently, both need to be running for correct operation. Confirm this before leaving an installation site.

2.7.1 Logger functions & Logging running state

At the appointed time, the built-in logger will go into the state of “Recording” and begin repetitive logging.

The logger will periodically sample the sensors employed by the PRV controller, but additional sensors can be optionally included in the built unit. These must be requested at the time of ordering; refer to the model-number scheme (shown later).

After taking several measurement samples, some statistical functions can be optionally applied to produce a datapoint that is logged (saved); a “point measurement” (a single data sample) can alternatively be saved. The rate at which these are recorded is known as the “log period”, which is always a multiple of the “sample period”.

The datapoints are stored in the memory of the unit. The unit calls into the cellular data network in order to contact the server; the data is then uploaded.

An installer can also download a copy of the data into the IDT tool for analysis on-site.

The logger can be programmed to monitor data for certain patterns or conditions and to send a message to the server if it should detect a match. Commonly, this is used for setting a condition to be detected by the unit that can be an indication of an “alarm”.

The logger makes measurements (as described above) into an area of memory which is referred to as the “primary recording”. If the logger has the feature enabled, it can also be set to occasionally save data into a “secondary recording” memory area, sampled at a higher frequency. This is not available on all supplied units and must be arranged through your sales representative before placing an order; it has implications concerning expected battery life of the unit.

Logging Running state:

The description (above) is only applicable while the logging functions are in a running state of ‘Recording’. However, the logger can be in one of the following states:

- **Stopped.**
(Also known as ‘Shipping Mode’).
The logger is dormant, awaiting activation.
- **Waiting.**
This is a transitional state, where the logger is no longer dormant, but is waiting for an appropriate time to start logging; logging start is aligned with the nearest convenient clock-time.
- **Recording.**
The logger is operating its repetitive logging cycle and other programmed tasks.

Further information is provided in the IDT user-guides. They are summarized here.

The **logging functions** of Pegasus2 are usually set to begin ‘immediately’ upon being ‘activated’ (e.g. for first-time use).

IDT is used for the activation. However, IDT (PC) and IDT (app) behave slightly differently in use. To activate the logger functions:

- The **IDT (PC version)** must first be used to **read** the logger's program into the PC memory. Then (possibly after some changes are made) the user must **manually save** the settings to the unit, using the 'Setup Device' button.

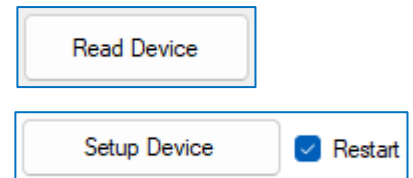

During the process, the program is saved and then read-back into IDT, along with the latest logger status; this will temporarily be 'waiting'. Also, IDT makes some checks for potential issues with logger setup and (if any are found) prompts the user to consider if the issue needs to be addressed.

- The **IDT (mobile app version)** also reads the logger's program into the phone's memory, but does so automatically, as soon as it has identified the unit. The user can choose to **manually** activate the logger (by tapping the Start Device button, found in the Device Information screen), or...

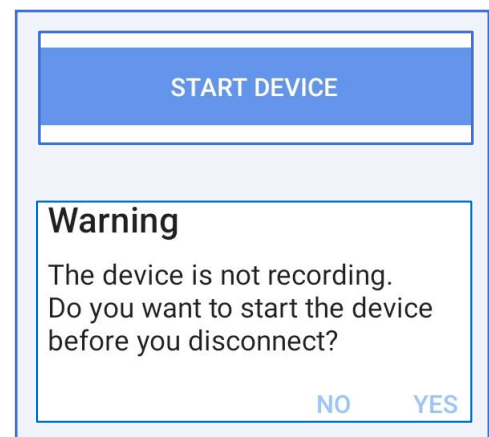

The app will advise that the settings should be saved and that the device should be re-started following certain program changes or user actions (e.g., when trying to disconnect from the device).

(Unlike IDT (PC version) the IDT app saves settings progressively during use, rather than waiting for the user to manually initiate the save).

Logging begins to be activated; It goes into the Waiting state for a short interval, after which it goes into the Recording state.

Checking Logging Running state:

In IDT (PC version), the *running status* of the built-in **logger** is shown within the Logger panel of the setup tab.

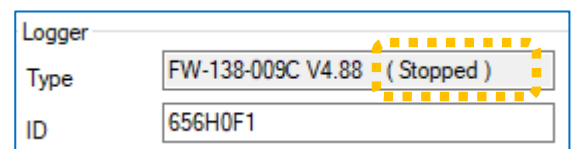

IDT App users:

The *running status* of the built-in **logger** is shown within the Device Information screen.

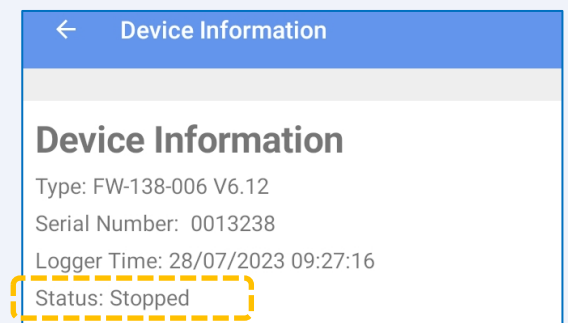

2.7.2 PRV Control functions & running state

PRV control is a separate activity to that of the built-in logger. The PRV controller samples various inputs and determines what action (if any) is required to modify the PRV output pressure.

The PRV control can be in one of the following states:

- **No Control**
The **automatic** PRV control process is stopped.
The PRV control process can still accept manual adjustments from user interaction with IDT.
- **Resuming / Pausing.**
This is a transitional state, which lasts fractions of a second.
The user has requested automatic PRV control to begin, or to be paused, but the device requires a short preparation time.
- **Start Control.**
The PRV control is operating **automatically**, periodically making new measurements and actioning any corresponding adjustments.

In IDT (PC version), the *running status* of the PRV control is indicated on buttons within the PRV installation tab.

Red = Automatic control stopped. (No Control)
Green = Automatic control running. (Start Control)

(The control state can be changed by clicking on the desired button. IDT may also suggest starting the controller).

The state of the **PRV controller** operation has no effect on the built-in logger operation.

Note: Operation of the system with a Pressure Reducing Valve is described later, in section 2.12.

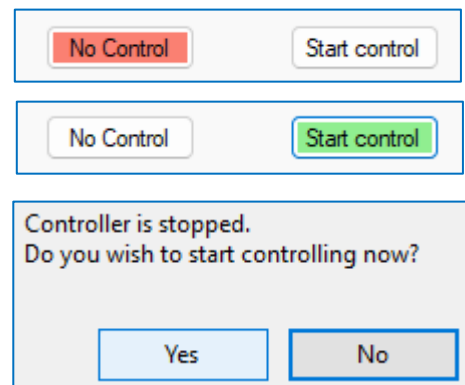

IDT App users:

Equivalent controls and indications of the **PRV controller** are located as follows:
(main)→Test Device→PRV Installation.

(The control state can be changed by tapping on the desired button)

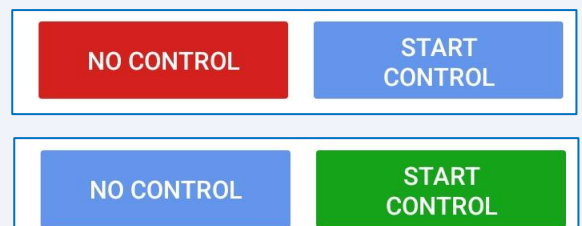

2.7.3 Controller Description

The Control Box unit directs the operation of the Solenoid Box unit. It contains inputs from all transducers, from which it makes decisions about how the system should respond to the current operating conditions.

The Control Box, shown opposite, contains:

- A quick-release connector for a water-pressure transducer (or a MIL-spec connector for an external transducer) that measures the inlet side of the PRV (upstream pressure).
- A quick-release connector for a water-pressure transducer (or a MIL-spec connector for an external transducer) that measures the outlet side of the PRV (downstream pressure).
- A MIL-spec connector for flow data. This measures the rate of flow of water (if a water meter is available on site to connect to).
- A MIL-spec connector to the Pegasus2 Solenoid Box.
- A connector for attachment of an Antenna for the cellular data network.
- A connector for communications and the external battery power option.
- (Optional) additional interfaces, such as an interface for other sensors or a Hydroswitch unit. These must be specified to your sales representative before ordering, as they not fitted as standard.



The front of the Control Box includes a part-number, an example of which is shown opposite:



The part-number describes the content of the unit, as follows ...

<u>Model Number(s)</u>	<u>Description</u>
C163C / * / * / * / *	Pegasus2 Controller

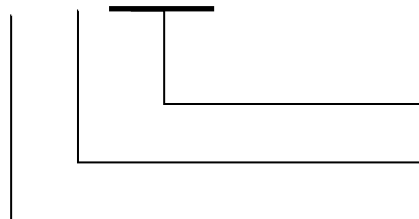

(Reserved by HWM for other options).
Electrical options.
Pegasus2 Control Box unit.

“Electrical options” is a 6-character field, as follows:

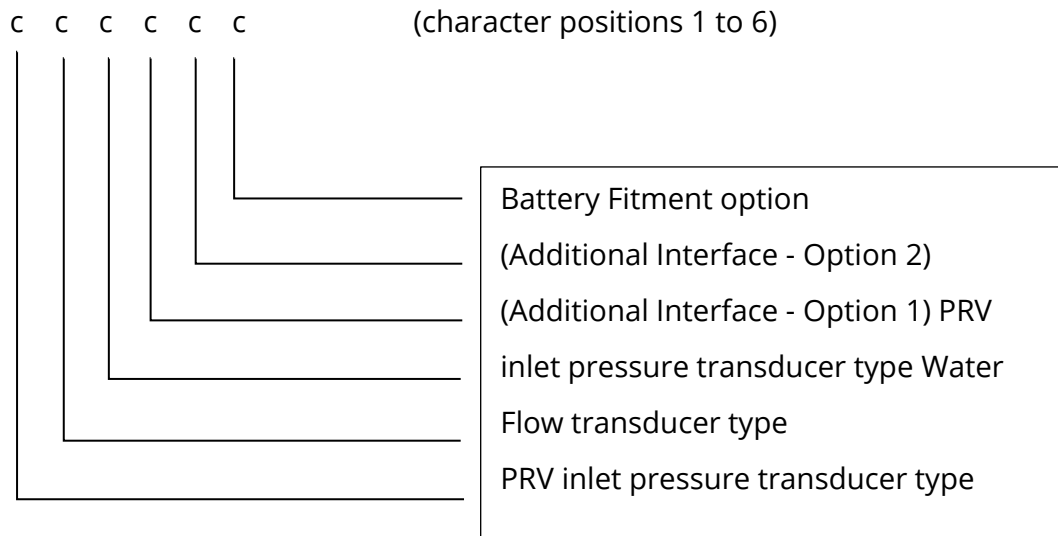

Pressure input (key):

- 3 – External Pressure sensor (electrical interface).
- 6 – Internal Pressure sensor (10-bar) with quick-release connector for water.

Water Flow input (key):

- 1 – Digital Flow (Meter pulse) Input.
Maximum of 128 pulses / second from a volt-free output.

Additional Options (key):

- 0 – (Option Not Fitted).
- H – HydroSwitch interface (alternatively can be used as a digital Status output).
- I – Electrical Interface (I2C).
- M – Electrical Interface (Modbus).
- 5 – Analogue (4-20mA) Flow input (Passive).
- S – Status Input.

Battery Fitment options (key):

- F – Fitted internally and also connected (standard).
- D – Fitted internally but disconnected.
- S – Shipped separately.
- E – Empty. (Fixings for internal battery are supplied, but no battery).
- N – (Nothing supplied: No internal battery. No fixings).

The Front of the Control Box is labeled to show the position of each of the standard connectors.

Non-standard connectors (for additional options fitted) are not labeled; refer to the model number and part-number guide (above).

An example of a unit with internal pressure sensors and a Hydroswitch interface is shown opposite.

(The 3-pin Hydroswitch interface, shown in dotted lines, is unlabeled).

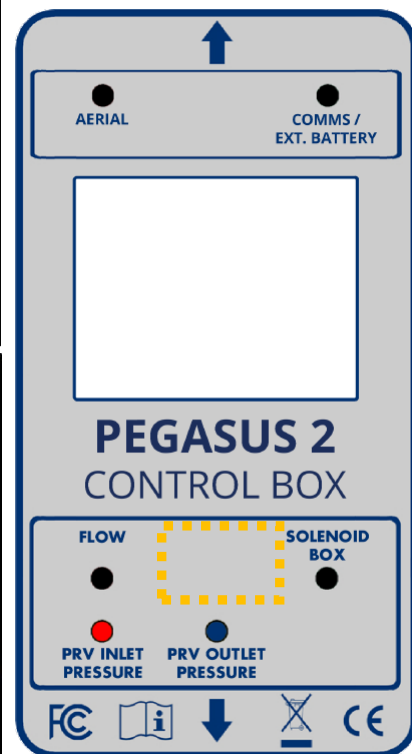

2.8 SOLENOID BOX - DESCRIPTION

The Solenoid Box operation is directed by the Control Box unit.

The Solenoid Box receives instructions from the Control Box via an interconnecting cable. The Solenoid box contains a set of solenoids which are connected to internal pipework. The pipework also connects to various water hose connectors presented on one side of the unit; these are for making connections to the external plumbing.

Each connector is labelled according to its standard use.

The Solenoid Box, shown opposite, contains:

- A set of hose connectors for connection to water-pipes required for the installation.
- A MIL-spec connector to the Pegasus2 Solenoid Box.
- (Optional) additional interfaces for Hydroswitch units. (0 up to a maximum of 2).
- An (optional) additional internal solenoid, known as a “latching solenoid”.

The front of the Solenoid Box includes a part-number, an example of which is shown below:

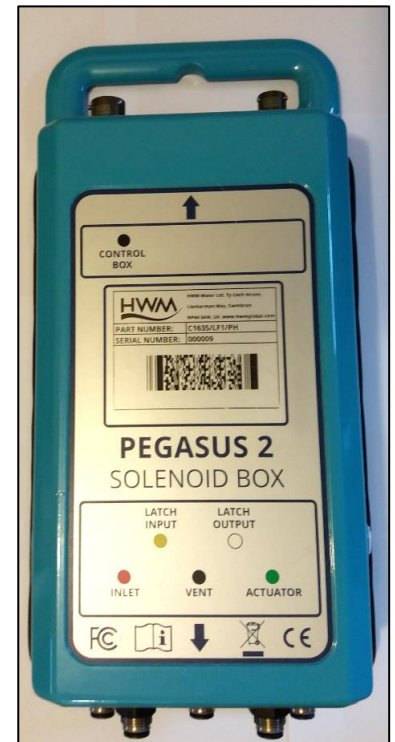

The part-number describes the content of the unit, as follows ...

<u>Model Number(s)</u>	<u>Description</u>
C163S/ * / *	Pegasus2 Controller

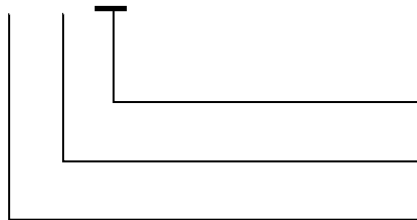

(Reserved by HWM for other options). Fitted options.
Pegasus2 Solenoid Box unit.

“Fitted options” is a 4-character field, as follows:

c c c c (character positions 1 to 4)

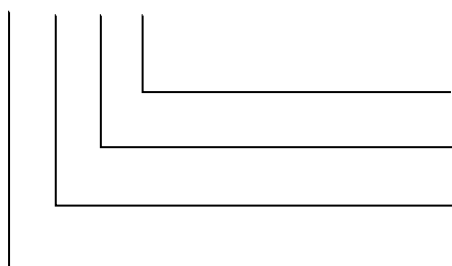

(reserved)
Hydroswitch (number of interfaces).
Battery Fitment option.
Solenoid type.

Solenoid type (key):

- L – Latching Solenoid (standard); referred to as a “Latching unit”.
- N – Latching solenoid is absent; referred to as a “Non-latching unit”.

Battery Fitment options (key):

- F – Fitted internally and also connected (standard).
- D – Fitted internally but disconnected.
- S – Shipped separately.
- E – Empty. (Fixings for internal battery are supplied, but no battery).
- N – (Nothing supplied: No internal battery. No fixings).

Hydroswitch interfaces (key):

- 0 – (none).
- 1 – 1 Interface
- 2 – 2 Interfaces

The Front panel of the Solenoid Box is labeled to show the position of each of the standard connectors.

Non-standard connectors (for additional options fitted) are not labeled; refer to the model number and part-number guide (above).

An example of a unit with one (optional) Hydroswitch interface is shown opposite.

(The Hydroswitch interface, shown in dotted lines, is unlabeled).

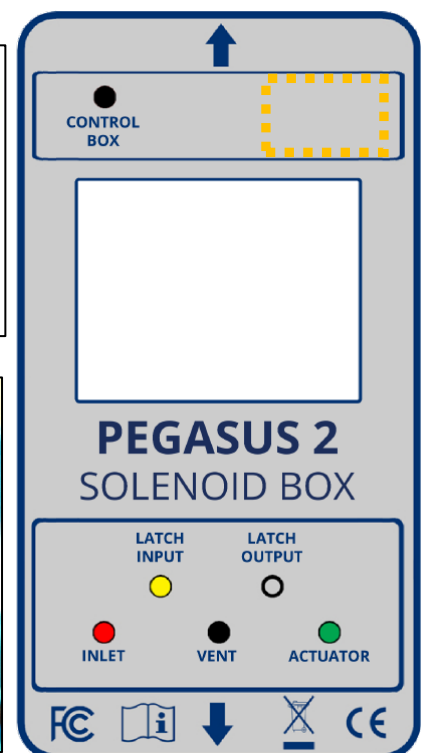
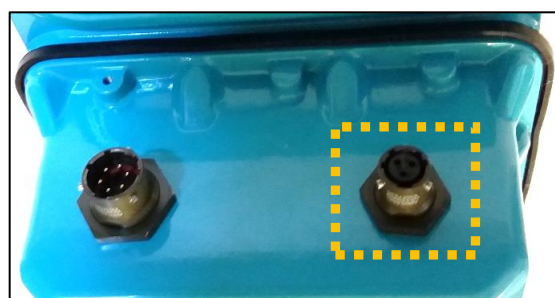

2.9 HYDROSWITCH - DESCRIPTION

The Hydros witch, shown opposite, is an optional expansion to the Pegasus2 system. It is a boxed unit with a 3-port latching solenoid valve attached via a cable.

The unit has a built-in cable with a water-proof connector.

The Hydros witch is powered by its own internal batteries. Its operation is directed by the Pegasus2 unit but takes approximately 10 seconds to change.

The Hydros witch does not form part of the basic Pegasus2 system but may be required for certain types of installation, (e.g. See section 6).

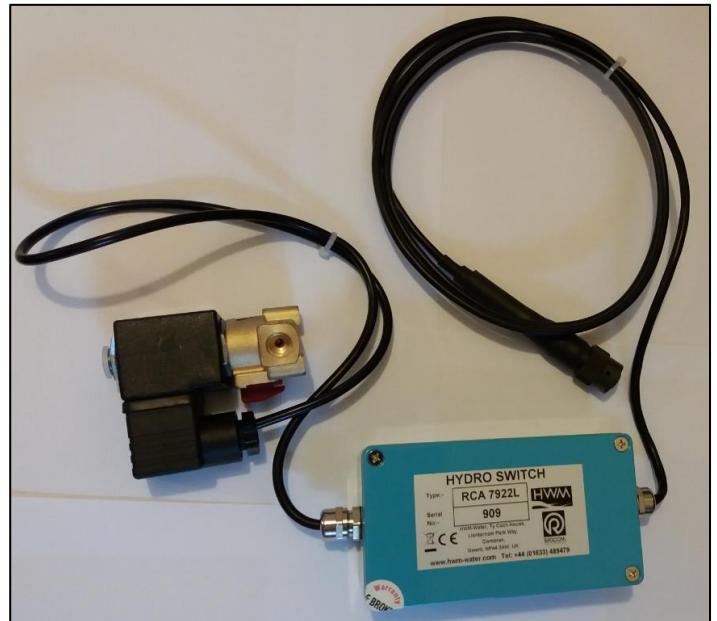

2.10 MECHANICAL ACTUATOR

In order to control the outlet pressure of a PRV the Pegasus2 system is required to modify the PRV behavior so that it produces downstream water pressure which follows the programmed pressure profile closely. This is achieved with the help of the HWM Mechanical Actuator, shown opposite.

The actuator consists of a diaphragm sandwiched between two concave plates. The one side of the actuator has threaded rod which has been drilled through its length to form a tube. Inside the tube is a plunger which is in contact with the diaphragm. On the other side of the diaphragm, the actuator forms a sealed chamber which can be inflated (or deflated) using hydraulic pressure; hydraulic pressure is supplied through a water-pipe connection, as shown below (via the green hose). The actuator therefore converts an applied hydraulic pressure into the mechanical position of the plunger. The end of the plunger exits the thread.



A PRV normally has its pressure regulated via some control mechanism (which may include a pilot valve), with its outlet pressure being set mechanically; Typically, this is by the manual adjustment of a setting screw which acts on a spring.

The actuator used within a Pegasus2 system replaces the setting screw. It allows the Pegasus2 to adjust the PRV pressure.



2.11 SUMMARY OF PRV FUNCTION (PILOT OPERATED)

(Readers familiar with PRVs controlled by pilot valve operation may skip to section

2.12). 2.11.1 Main valve

The main components of a Pressure Reducing Valve (PRV) are shown opposite.

A plunger within the valve body is able to close onto the valve seat (closing off water flow) or open (allowing water flow). Depending on the position of the plunger, the flow has a variable restriction. The restriction reduces the outlet pressure when water is flowing. The plunger position is influenced by the water pressure on both the inlet and outlet sides of the valve seat, internal springs acting on the plunger, and also the position of a diaphragm which is attached to stem of the plunger.

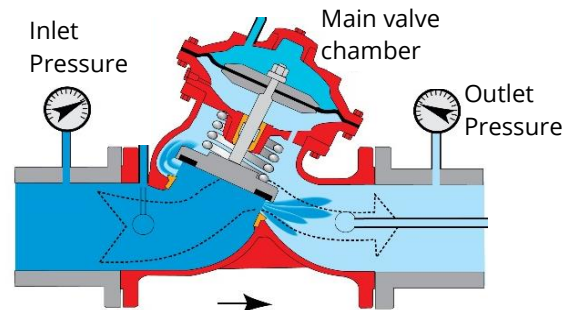

Valve Open (flowing condition)

The diaphragm changes position in a manner dependent on the difference in pressure either side it. The pressure on the diaphragm is usually under control of components external to the main valve body, including a pilot valve.

2.11.2 Pilot Valve operation

A typical pilot valve is shown in the diagram opposite.

It is constructed with a plunger which has its stem connected to a diaphragm. The position of the plunger is dependent on any forces acting either side of the diaphragm; the force on the lower side being provided by water pressure and the force on the upper side being provided by the compression of a spring. The spring compression can be adjusted by means of an adjustment bolt which re-positions the top seat of the spring.

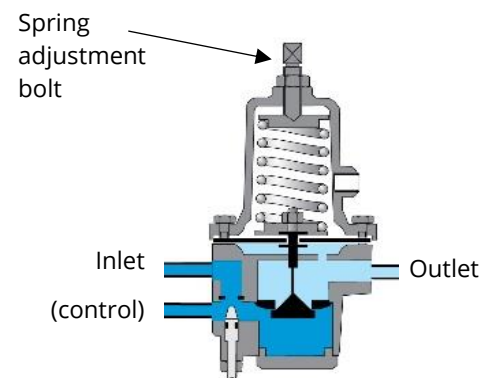

The water flowing into the pilot valve via the inlet port is restricted. This is typically done by a needle valve which may be either internal to the pilot valve or external to it (within the pipe feeding upstream water to the inlet of the pilot valve).

When the pilot valve opens, some of the water flows across the valve (due to pressure difference) and leaves via the outlet port. A 3rd port is available, used for control of the main valve.

The needle valve is sometimes referred to as a "speed control". It prevents damage to the PRV by limiting the speed of change to volume of water in the PRV upper chamber.

2.11.3 Pilot operated pressure reducing valve

A pilot operated pressure reducing valve automatically and accurately reduces downstream water pressure to a specific, adjustable value.

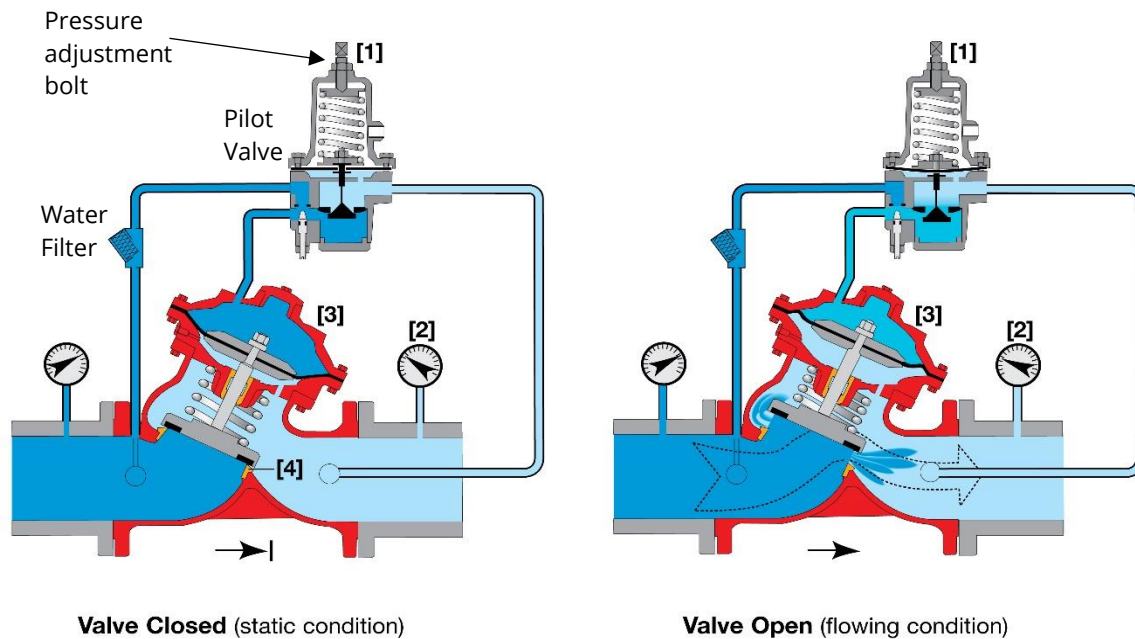

The Pressure Reducing Pilot [1] senses downstream pressure [2] and in real time modulates the top chamber of main valve [3] to maintain a constant downstream pressure.

In no-flow static conditions, should the downstream pressure start rising above the pilot setting, the pilot closes, shutting the main valve [4] to maintain the allowable downstream pressure.

The upstream water is connected to the Pressure Reducing Pilot [1], which is subsequently connected to the top chamber of the main valve [3]. If this pressure is such that the Pilot remains closed, the upstream pressure is the same as the top chamber of main valve pressure. The pressure is balanced, and the valve is closed by the tension in the spring.

Note: The pilot set point is adjusted by turning the pilot adjustment bolt and is not dependent on upstream pressure.

Increasing spring force sets a higher output pressure.

Reducing spring force sets a lower output pressure.

However, if the upstream water pressure in the Pressure Reducing Pilot [1], does allow the Pilot to open, the water exits the valve and becomes downstream water, but more importantly, the pressure in the top chamber of the main valve [3] is now less than the upstream pressure. This pressure differential causes the valve to open.

2.12 PRV FUNCTION (UNDER PEGASUS 2 CONTROL)

2.12.1 Pegasus 2 Mechanical Actuator

The HWM Pegasus2 includes the HWM mechanical actuator, which attaches to the top of the pilot valve, replacing the adjustment bolt.

Pegasus2 is able to control the spring force by adding or removing water from the upper chamber of the actuator. This operates a rod internal to the device (the stem of the plunger) which connects to the seat of the spring.

Pegasus2 adds or removes small quantities of water to the actuator, allowing fine control of the position of the upper end of the spring (between set limits); the limits are adjustable. The procedure for installing the actuator and setting its limits is covered in sections 4.12 and 4.13.

The pilot setting can therefore be continuously adjusted by Pegasus2, thereby allowing control of the downstream water pressure.



2.12.2 Pegasus 2 System options: (Basic and “Latching” models)

All Pegasus2 systems contain ports labeled “Actuator”, “Inlet” and “Vent”. These are connected to the internal solenoid valves and are required for modulating the PRV output pressure between the maximum and minimum pressures via use of the actuator. Basic models (also known as “non-latching” models) contain only these ports.

Pegasus2 systems are also available with an additional solenoid; these are known as “Latching” models.

These models contain an additional two ports, labeled “Latch input” and “Latch Output”. The ports are connected to the additional solenoid valve and can be utilized to give some additional control over the PRV behavior under certain conditions.

The differences in the two types of Solenoid box (latching vs non-latching) is illustrated in the diagrams below:

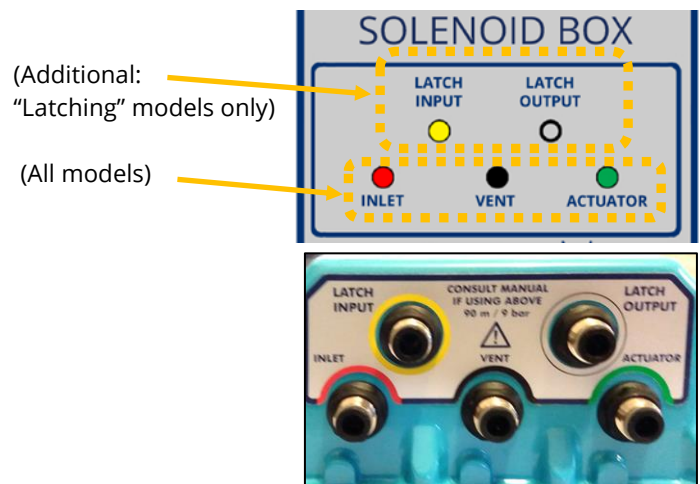

Non-latching versions:

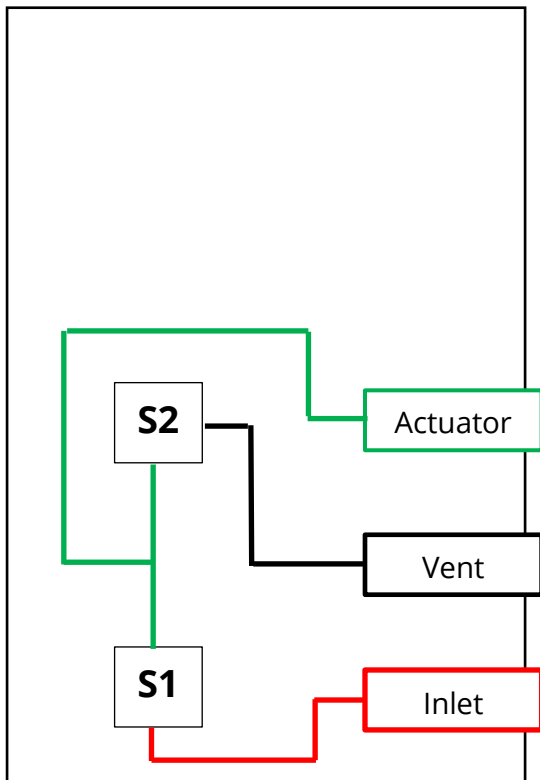

Latching versions:

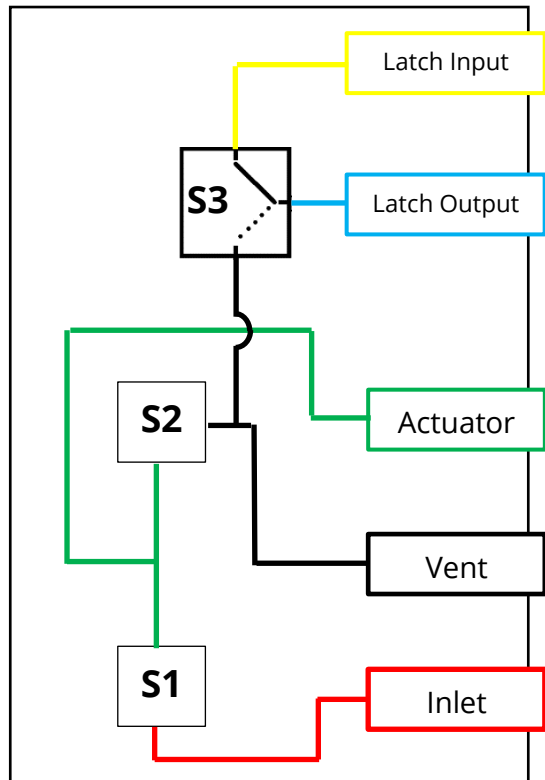

S1 and S2 are 2-port valves which are normally sealed. An electronic pulse to one of the valves momentarily actuates it and allows a small quantity of water to flow through it. S3 (where fitted) is a 3-port valve with a common port. An electronic pulse to the valve can change its state and allows water to flow between the common port and one of the other ports; The remaining port becomes sealed.

The Solenoid box ports are color-coded to assist with identifying their connection. It is possible for the installer to similarly use colored pipes.

2.12.3 Explanation of Latch Solenoid activation (High and Low unreachable)

When Pegasus2 is controlling the PRV, it has a target outlet pressure which it is trying to achieve. It pulses internal solenoids S1 and S2, as required.

- If Pegasus2 is **repeatedly trying to increase** the output pressure, but not reaching the target pressure, this is known as a '**High unreachable**' condition.

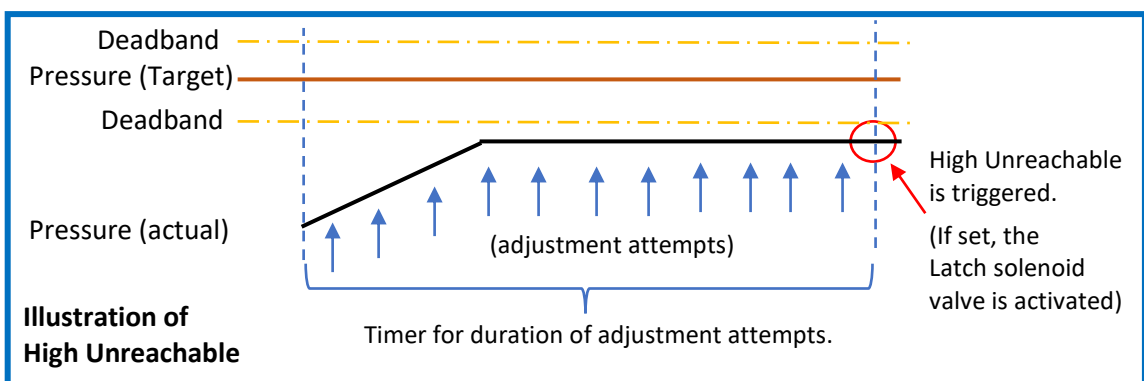

- If Pegasus2 is **repeatedly trying to decrease** the output pressure, but not reaching the target pressure, this is known as a '**Low unreachable**' condition.

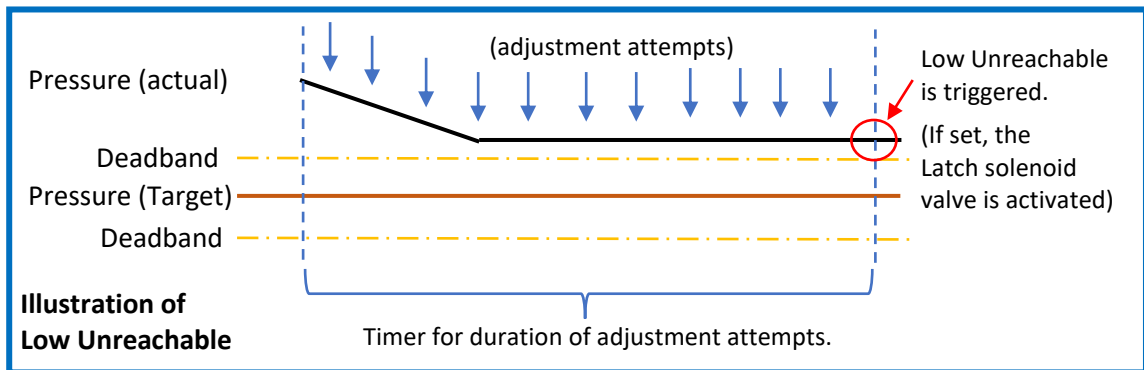

The High unreachable or Low unreachable conditions depend upon a programmable minimum time interval, during which the target pressure has not been achieved. Only one of these conditions can be set to apply to an installation. When the condition is triggered, it can be set to activate the S3 latched solenoid (valve).

Normally, the latch solenoid is deactivated, allowing Pegasus2 to provide fine pressure regulation of the water supply via control of the pilot valve. However, when the latch solenoid is activated, the Pegasus2 (which must be suitably plumbed into the installation, and have appropriate settings), can by-pass the pilot valve to get closer to the target pressure.

Pegasus2 will resume normal control when the output pressure is 2m above the target pressure (for a High unreachable state) or 2m below the target pressure (for a Low unreachable state); The S3 solenoid (valve) is once more de-activated.

Information regarding settings are provided within section 4.20.

2.12.4 Theory of operation (Continuous pressure modulation)

The plumbing of a simple Pegasus2 installation is illustrated below: It uses a "non-latched" model version.

Note: Alternatively, a model that includes a latch solenoid can be used, with the latch ports not connected, and "No latch" selected in Pegasus2 program settings.

(Refer to the installation examples illustrated in sections 3.2.1, 3.2.2, 3.2.3, 3.2.4)

Note: This illustration uses a standard Pegasus2 plumbing scheme and operation. It requires the following Pegasus2 settings in IDT:

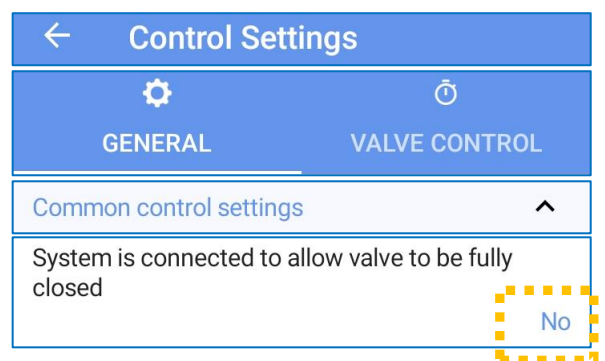
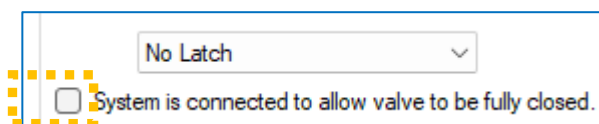

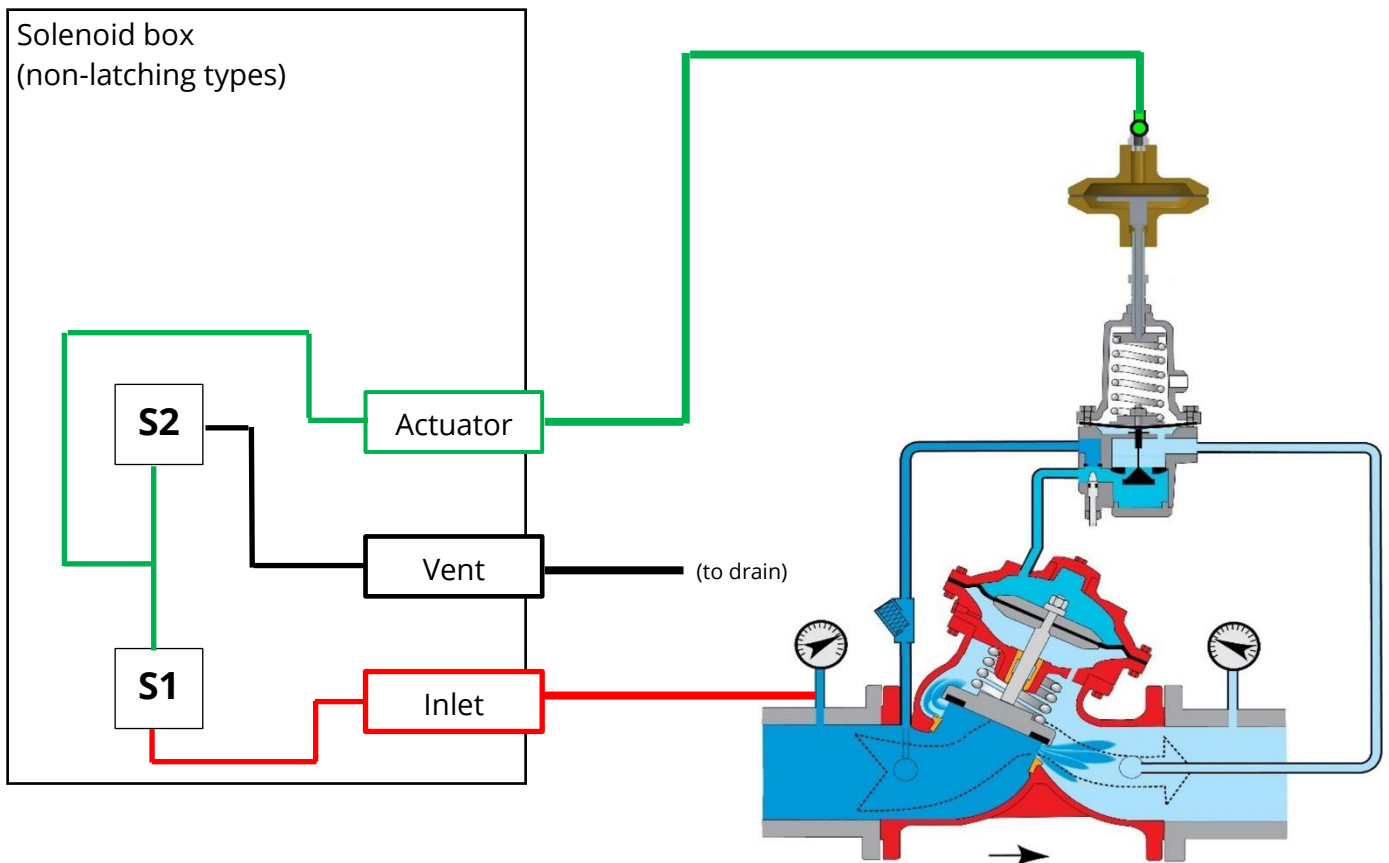

The Inlet port connects to the upstream side of the PRV (as long as its pressure is below 90m), which provides pressurized water for the system to use.

The controller can pulse solenoid valve S1 to slightly inflate the upper chamber of the HWM mechanical actuator. This increases the outlet pressure.

The controller can pulse solenoid valve S2 to slightly deflate the upper chamber of the HWM mechanical actuator. This decreases the outlet pressure. A small amount of water is discharged to the vent port, where it should be piped away from Pegasus to drain at a suitable location.

Changes for High Inlet Pressure

The Pegasus2 actuator and the Solenoid box components may become damaged if the pressure feed into the unit is excessive (greater than 90m). In this situation, it is often possible to use Pegasus2 safely by plumbing the Solenoid box unit into the PRV outlet to obtain water at a lower pressure, as shown below:

Caution:

When PRV inlet pressure exceeds 90m, an alternative installation is required... Use the downstream water pressure for the Pegasus inlet port instead, as shown.

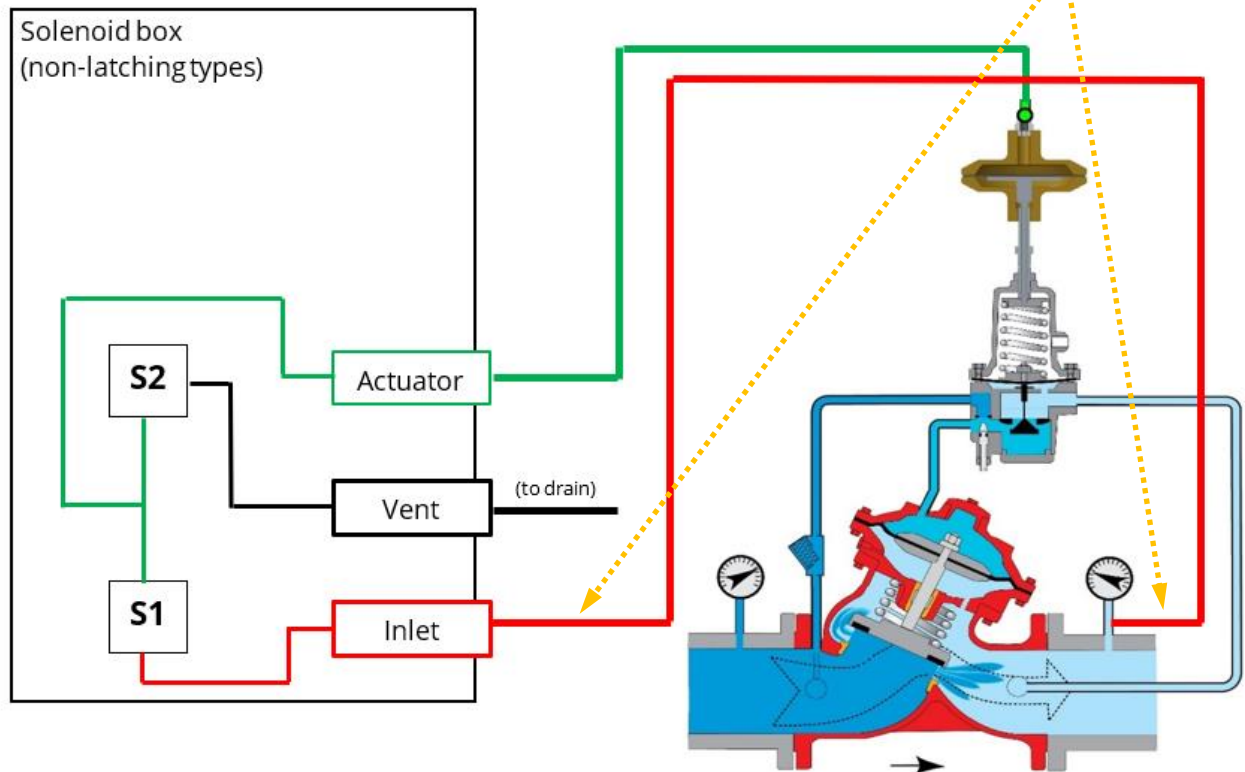

2.12.5 Theory of operation (Continuous pressure modulation + Latch)

Pegasus2 models with the 'Latch' option fitted have an additional internal solenoid and associated ports ('Latch Input' and 'Latch Output'). This facility (when correctly plumbed in and set up) can be used to improve the management of outlet water pressure or flow during certain conditions.

Caution: If incorrectly plumbed into the circuit or incorrectly set the outcome can have an adverse effect, rather than favorable. Be sure the plumbing and settings suit the desired use application of the unit.

2.12.5.1 Standard Operation

Continuous pressure modulation can be similarly implemented using a latched model version when plumbed into the PRV as shown below, provided the relay S3 is not activated.

The plumbing for use with standard operation of Pegasus2 (with latch) is shown below. (Refer to the installation examples illustrated in sections 3.3.1, 3.3.2, 3.3.3, 3.3.4)

Note: Standard plumbing and operation requires the following Pegasus2 settings in IDT:

No Latch v
 System is connected to allow valve to be fully closed.

System is connected to allow valve to be fully closed
No

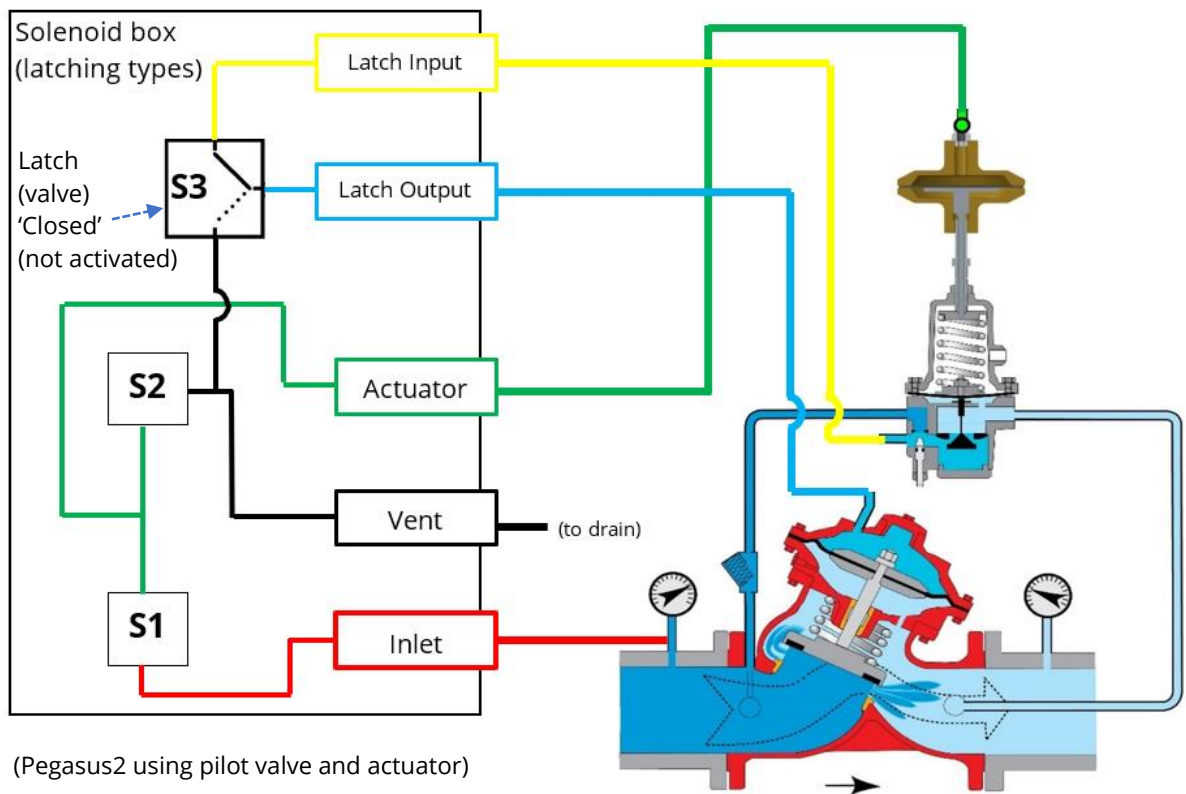

The connection between the pilot valve and the upper chamber of the PRV simply passes through the Latch solenoid, rather than being directly connected.

Whilst S3 is in the position shown, operation is identical to that previously described for the non-latched model (see section 2.12.4).

When the solenoid Latch (S3) is activated, the valve is switched over (by an electronic pulse) to a new position; it maintains its new position until de-activated (requiring another electronic pulse).

With the valve now in its new position, the Latch Input side is sealed and therefore has no water flow. Water from the upper chamber of the PRV is discharged through the port labeled "Latch out" to the Pegasus2 port labeled "Vent" (and subsequently to a drain). The upper chamber of **the PRV empties**, allowing the PRV to **open fully**, so that the water flows through the PRV at maximum flow rate.

This gives **minimum pressure loss** across the PRV.

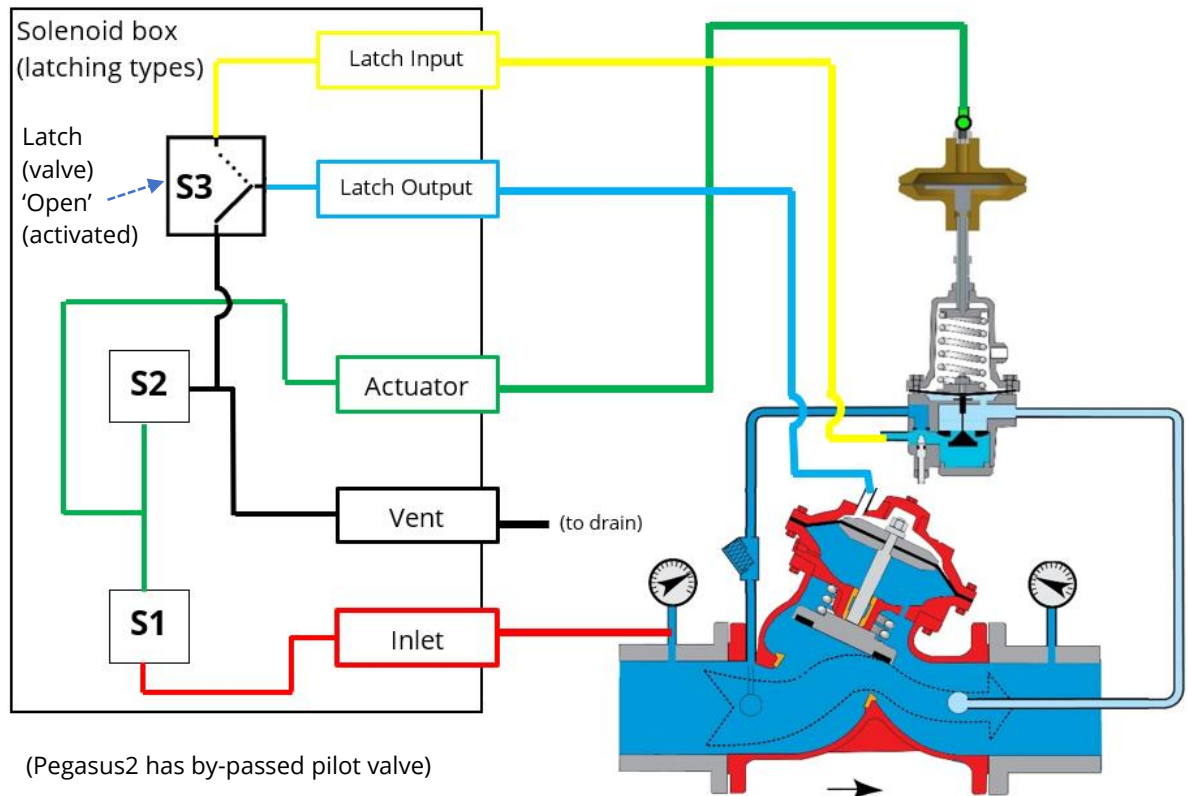

Applications

- The “standard installation” type, when used with the **‘Latch on high unreachable’** setting provides Continuous Pressure Modulation by using the mechanical actuator to control the PRV pilot valve. (i.e. Normally the latch solenoid valve is not activated). In addition, during times when the inlet pressure is low (e.g. being marginally above the target output pressure), control by using the pilot valve may introduce too great a pressure drop to achieve the target pressure. The Pegasus2 detects this and can activate the Latch circuit, as described above. This provides a small increase in the output pressure. When the inlet pressure improves (rises again), Pegasus2 also detects this, de-activates the Latch circuit, and changes back to the regular control (modulating the PRV pilot valve).

Note: **Do not use** the “Latch on low unreachable” setting with this configuration. (If the latch circuit is triggered it can adversely affect the outlet water pressure).

Note: The two preceding diagrams show pressurized water being supplied from tapping into the PRV inlet side. Where this pressure is excessive for Pegasus2 internal components, it is sometimes possible that it can be supplied from the PRV outlet side (downstream pressure).

2.12.5.2 Non-standard operation (and plumbing)

There is an alternative way to plumb a Pegasus2 (**set for modified operation**) into a PRV installation, an example of which is illustrated below:

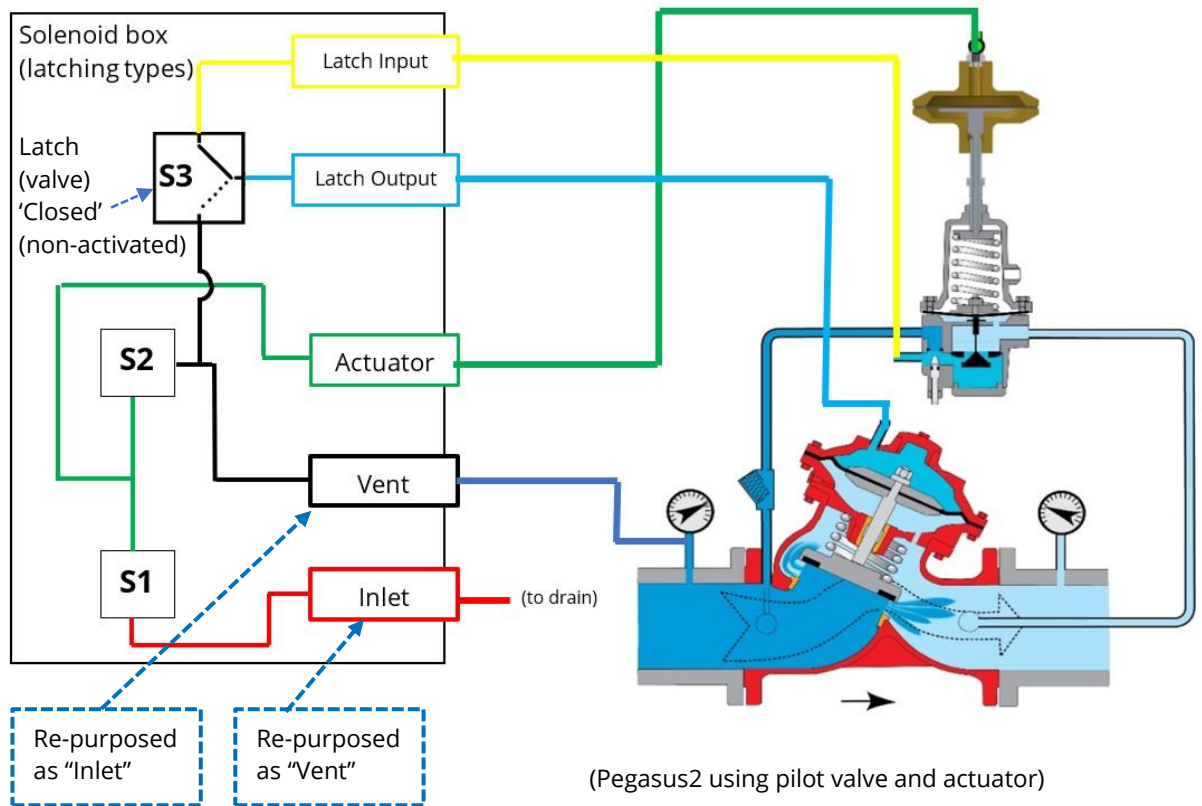

Note: The Pegasus2 Vent and Inlet ports **are re-purposed** by swapping over their functions and plumbing. This also requires a change to the electronic configuration of the unit's function for solenoids S1 and S2 (using IDT).

To set Pegasus2 to use this non-standard plumbing (and operation) ensure the 'System is connected to allow valve to be fully closed' setting is enabled (ticked or Yes), as shown below:

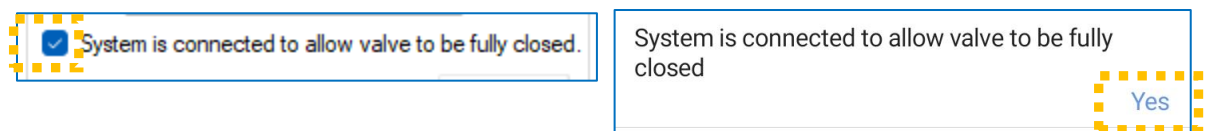

There will be a warning when setting this; Only proceed if this irregular setup is the desired installation type and use of the Pegasus2.

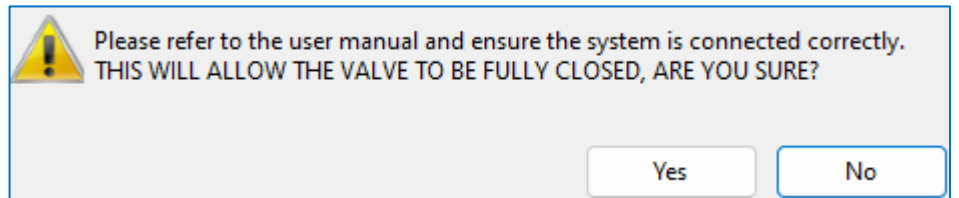

Once the settings **have been saved** to Pegasus2 it changes internal operation (re-purposes the 'vent' and 'inlet' ports), making it compatible with the non-standard plumbing.

With the Latch solenoid in the position shown above, the water pressure supplied through the port labeled “Vent” (which is re-purposed as the inlet port) is used to slightly inflate the mechanical actuator when S2 is given a short electronic pulse.

A short electronic pulse to solenoid valve S1 will slightly deflate the mechanical actuator by discharging a small volume of water through the port labeled “Inlet” (which is re-purposed as the Vent port).

By sending pulses (as required) to the S1 and S2 valves, Pegasus2 can finely control the outlet pressure, via taking control of the pilot valve.

When the Latch (S3 solenoid) is activated, the valve is switched over to a new position; it maintains its new position until de-activated.

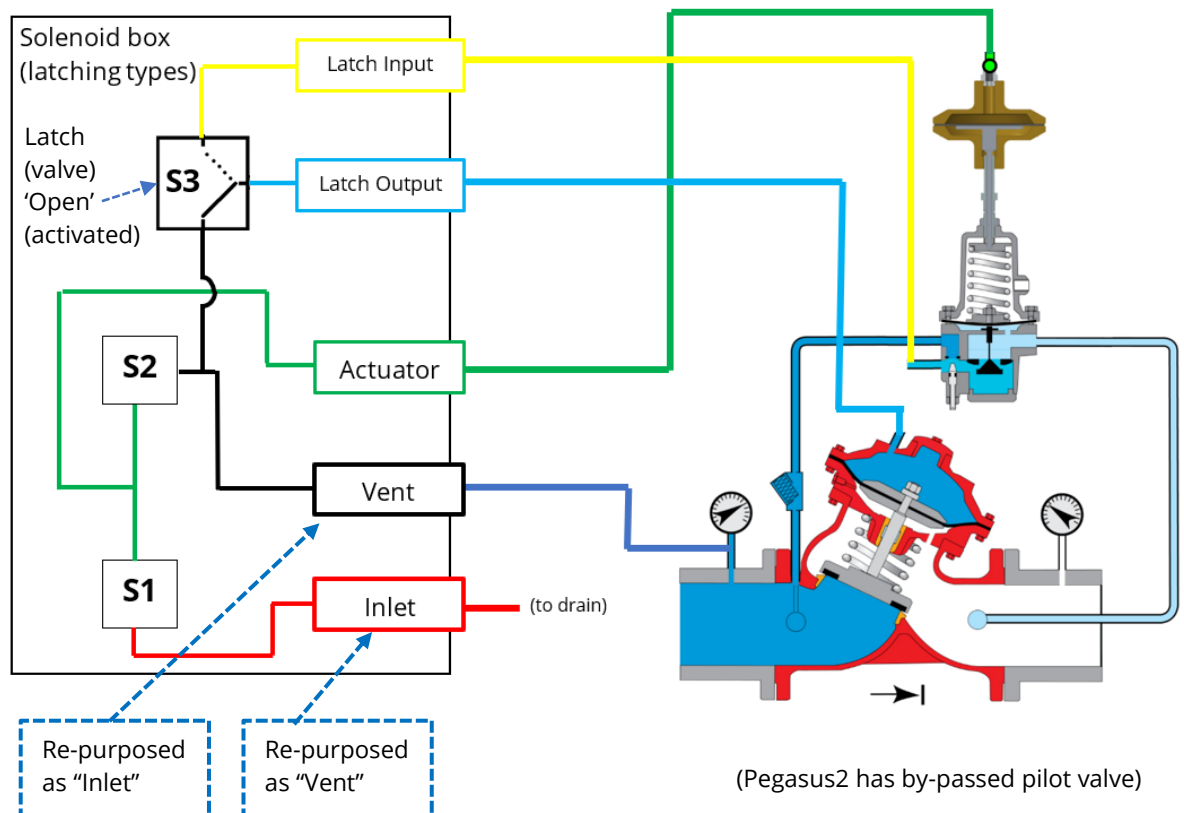

With the valve now in its new position, the Latch Input side is sealed and therefore has no water flow; the pilot valve is by-passed. The upper chamber of the PRV is **fully inflated** by water flowing into the Pegasus2 port labeled “Vent” (which is re-purposed as the inlet port). This causes the PRV to **fully close** so that the water flows through it at its minimum flow rate. This gives **maximum pressure loss** across the PRV.

Applications

- The “non-standard installation” type can be used by water companies that require an area (e.g. An industrial area operating only during the day) to have water supplied at a regular operating pressure during part of the day, but where the water supply can be shut off at other times.

To accomplish this, the target pressure can be set to regular operating levels during the times when the water supply is required. However, when the water supply is not required, the target pressure can be set to zero (0m), This will minimise the PRV

output pressure.

When non-standard installation is used with the '**Latch on low unreachable**' setting, the Pegasus2 will detect if 0m is not being achieved and will subsequently activate the Latch circuit. This will further lower the pressure output, by causing the PRV to close.

When the water supply is required to return, the target pressure will increase. Since the measured pressure (0m) is now below the new target pressure, the Pegasus2 de-activates the Latch circuit, and changes back to the regular control (modulating the PRV pilot valve). Pegasus2 adjusts the mechanical actuator until the water supply is restored (at the target pressure).

Note: **Do not use** the "Latch on high unreachable" setting with this configuration. (If the latch circuit is triggered it can adversely affect the outlet water pressure. It has the capability of making the PRV **shut off the water supply** under certain circumstances).

Note: For this configuration, the pressurised water must be supplied from tapping into the PRV inlet side; Use of downstream water is not possible as, at times, the pressure will become insufficient. Do not use in situations where the pressure is excessive for Pegasus2 internal components.

3 CONFIGURATION OPTIONS (DIAGRAMS)

The following sections illustrate some of the possible installation configurations that are achievable using the basic Pegasus2 system.

3.1 KEY TO COMPONENTS WITHIN THE DIAGRAMS

To assist understanding of the diagrams, details of the various other components surrounding the PRV are shown below.

Inlet water filter

Helps prevent foreign bodies entering Pegasus2 (due to water quality).



3-way valve

The 3-way valve provides a means to manually switch between control by the Pegasus2 system or an alternative setting (typically used to be able to manually drive the PRV pilot to the setting required for maximum downstream pressure) or a safety override.

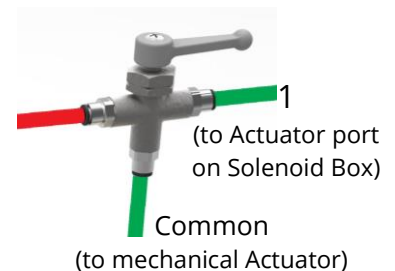

HWM mechanical actuator

Provides a means to set mechanical Maximum and Minimum settings on the pilot.

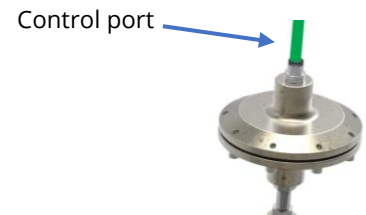

Pilot valve

The pilot valve fitted to the PRV.
(Image shown is for illustration purposes only)



Needle valve

The needle valve provides a restricter that slows down the water flow into the PRV upper chamber.
The needle valve is normally situated on the pilot rail.
(Image shown is for illustration purposes only)

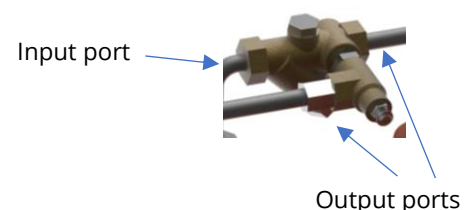

Flow meter

The diagrams shows a flow meter.

The Pegasus2 system provides models that can interface with various types of flow meters (e.g. Pulse or analogue).

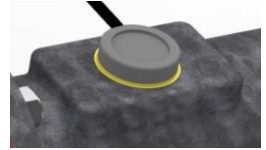

Pressure Reducing valve (PRV)

The PRV can be fitted with pressure connectors to monitor the inlet and outlet pressure, sometime these access points are on the body of the PRV (as shown in the diagram) or on the pilot or pilot rail.

(Image shown is for illustration purposes only)

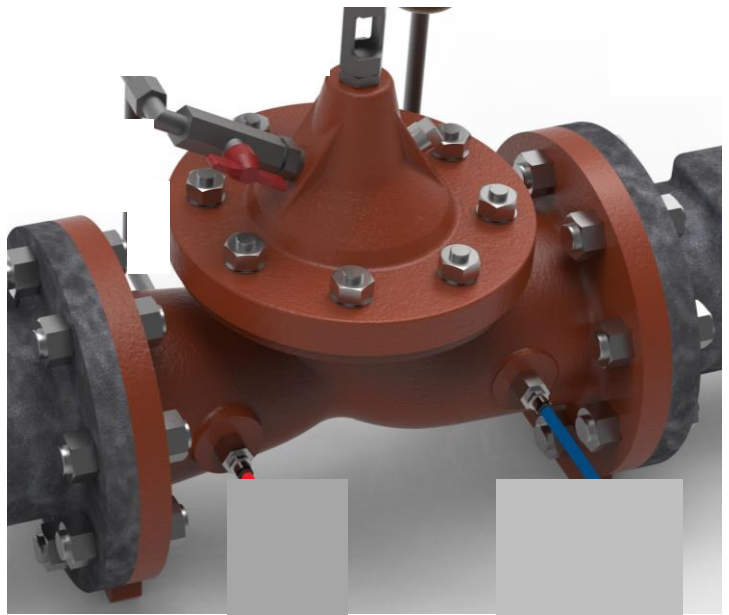

Pegasus 2 Solenoid box

The Pegasus2 solenoid box is shown opposite.

The Inlet and Actuator connections are always plumbed into the system.

The vent port connection to a drain is omitted from certain drawings in this manual for simplicity.

The unit has a cable connection to the Control box.

The "optional" latch connectors can also be plumbed here.



Pegasus 2 Control box

The Pegasus2 control box is shown opposite.

The unit receives water flow information from a flow meter (not supplied) via the connector labeled “Flow”.

The unit receives upstream water pressure information via the connection labeled “PRV Inlet Pressure”. This could be either via a plumbed-in connection to the water (for a unit which has an internal pressure transducer) or via a MIL-spec connection (where external pressure transducers are used).

The unit receives downstream water pressure information via the connection labelled “PRV Outlet Pressure”. This could be either a plumbed-in connection to the water (for a unit which has an internal pressure transducer) or via a MIL-spec connection (where external pressure transducers are used).

The unit has a cable connection to the Solenoid box. It also has a connection to an Antenna.

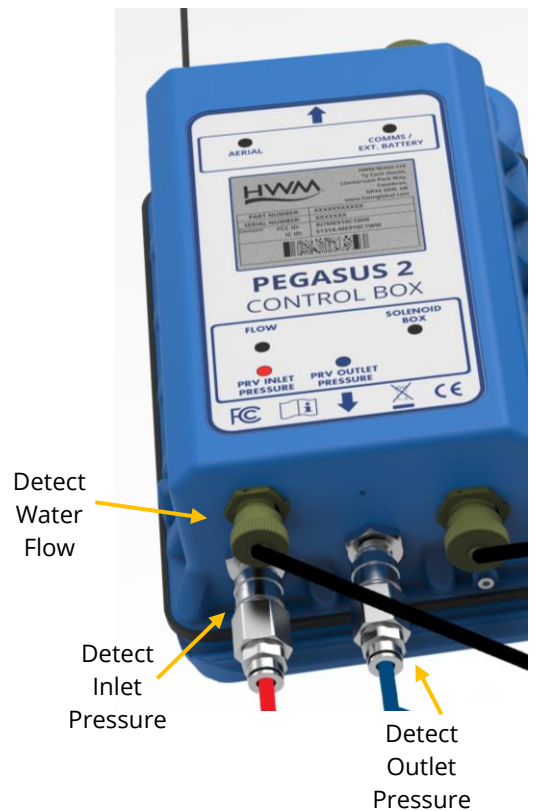

3.2 STANDARD INSTALLATIONS: CONTINUOUS PRESSURE CONTROL

3.2.1 Using: internal transducers (Pressure in < 90m)

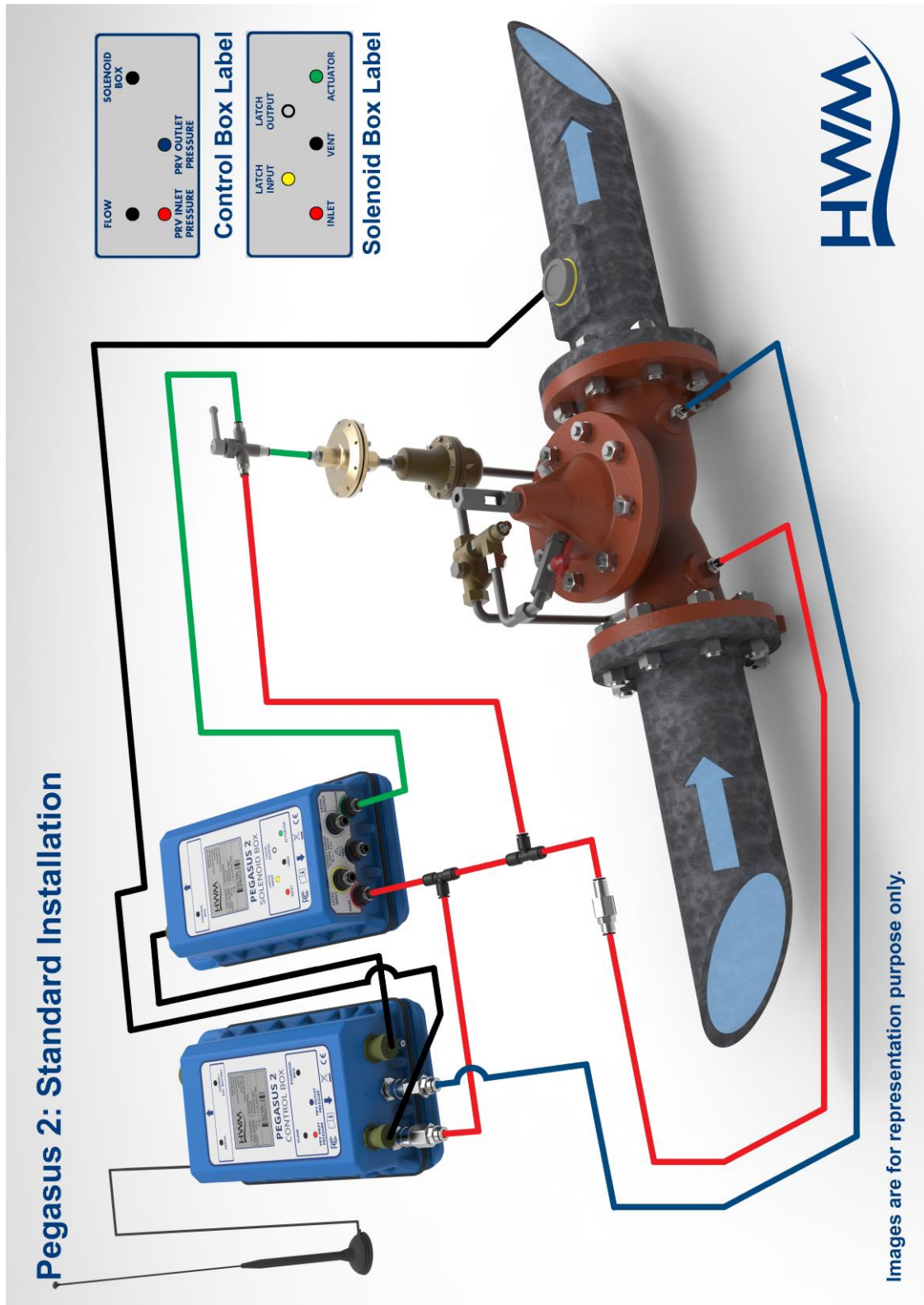

3.2.2 Using: external transducers (Pressure in < 90m)

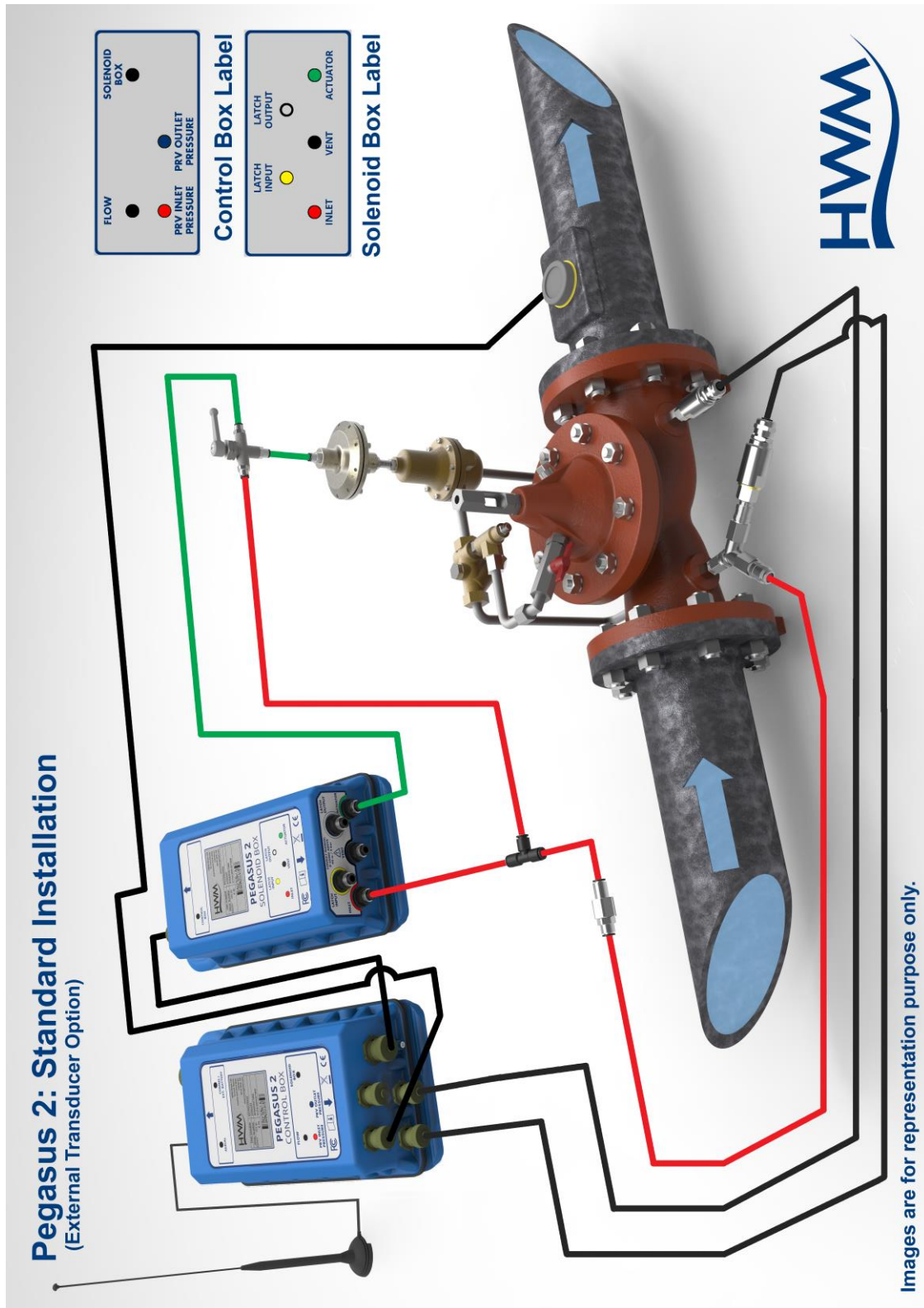

3.2.3 Using: internal transducers (Pressure in > 90m)

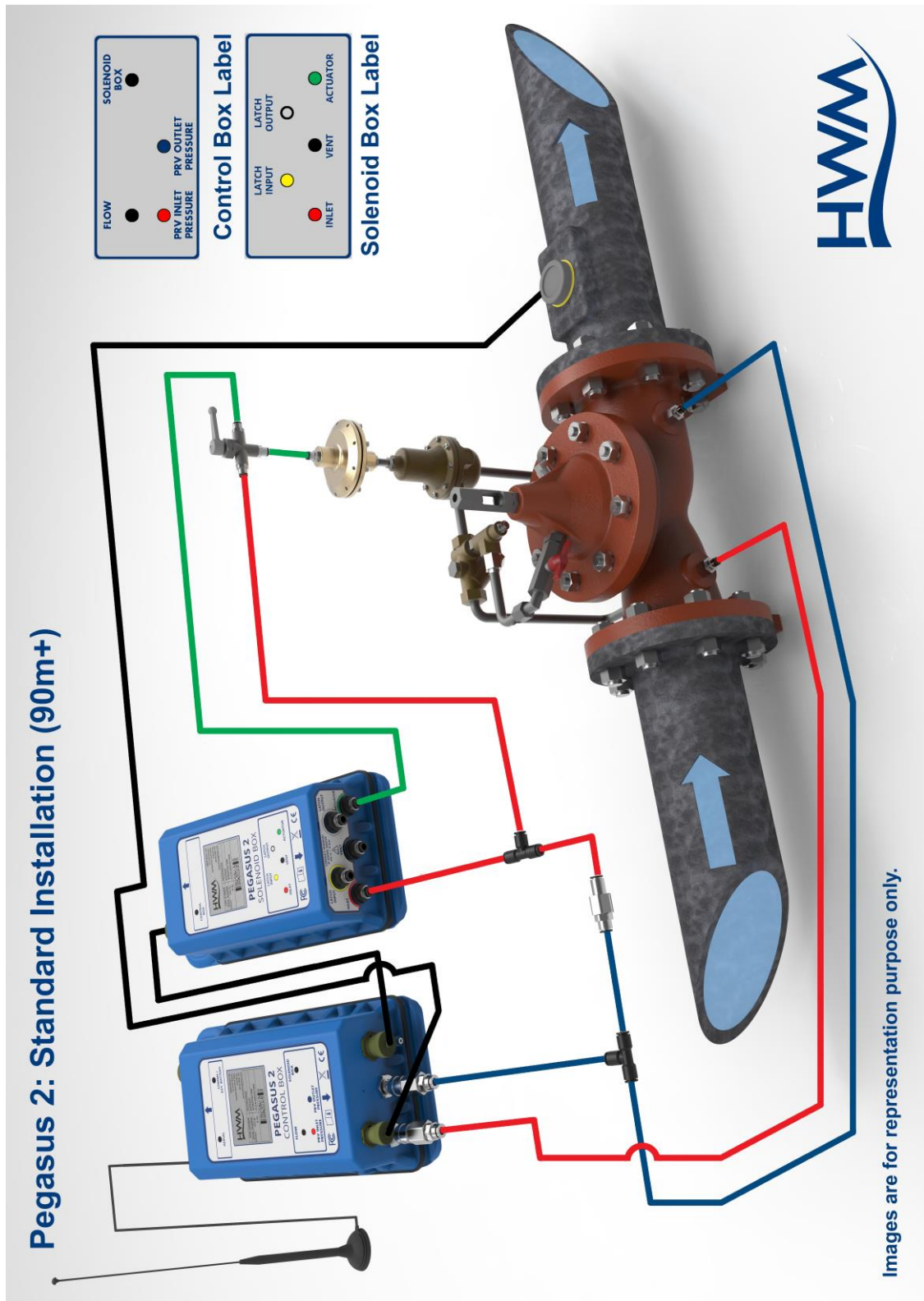

3.2.4 Using external transducers (Pressure in > 90m)

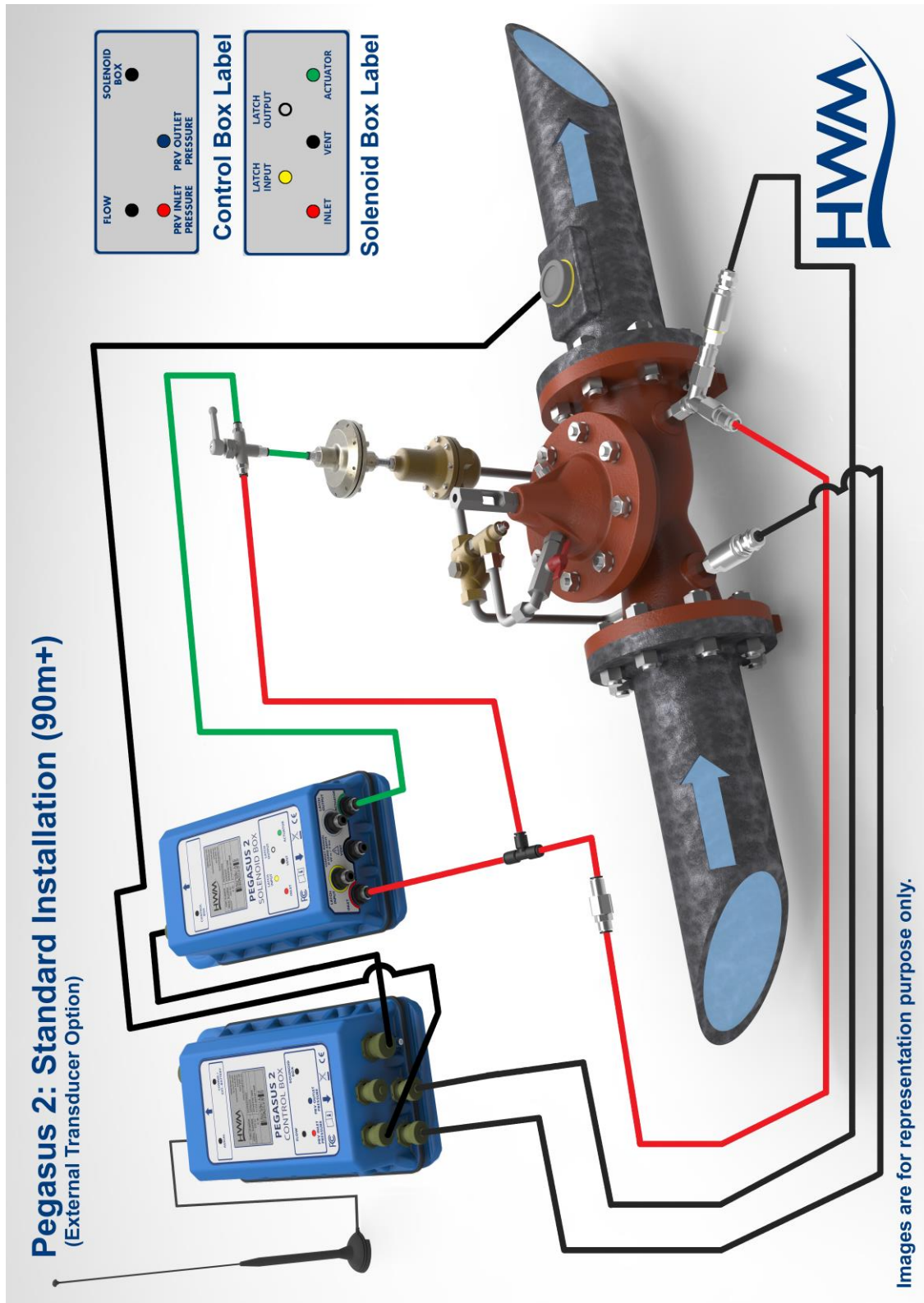

3.3 STANDARD INSTALLATION + HIGH PRESSURE UNREACHABLE

3.3.1 Using: Latch solenoid / internal transducers (Pressure in < 90m))

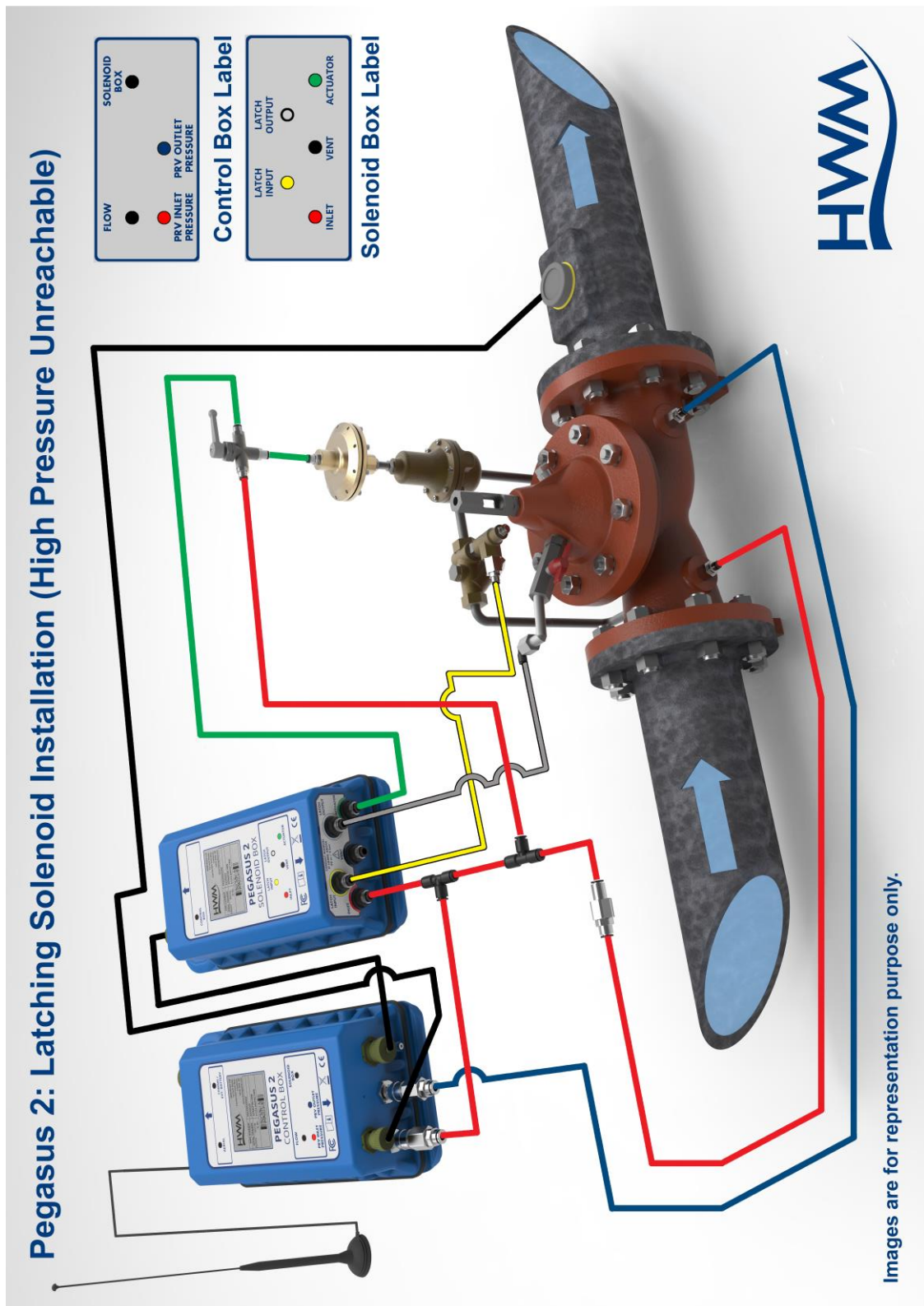

3.3.2 Using: Latch solenoid / external transducers (Pressure in > 90m)

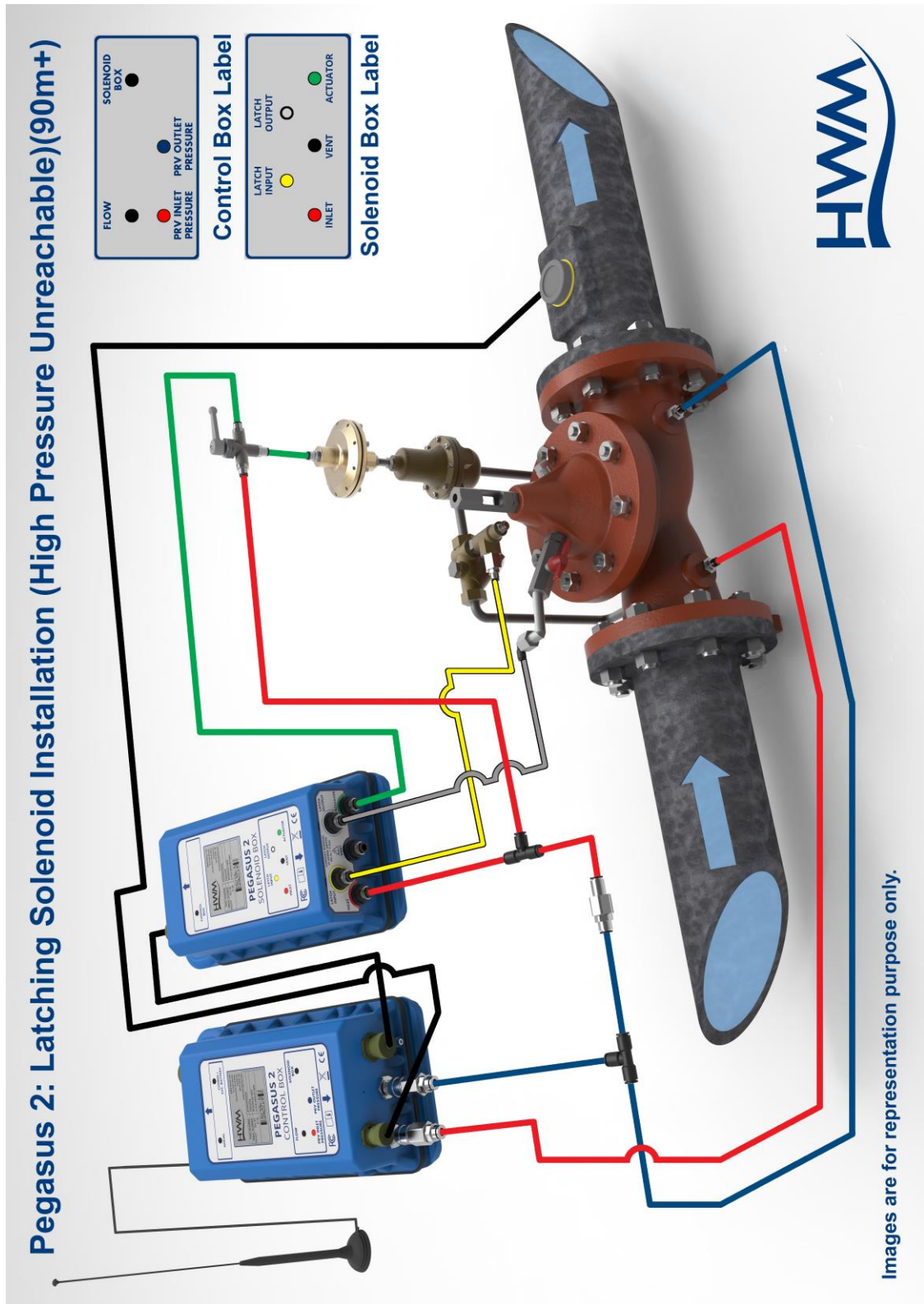

3.3.3 Using: Latch solenoid / internal transducers (Pressure in < 90m)

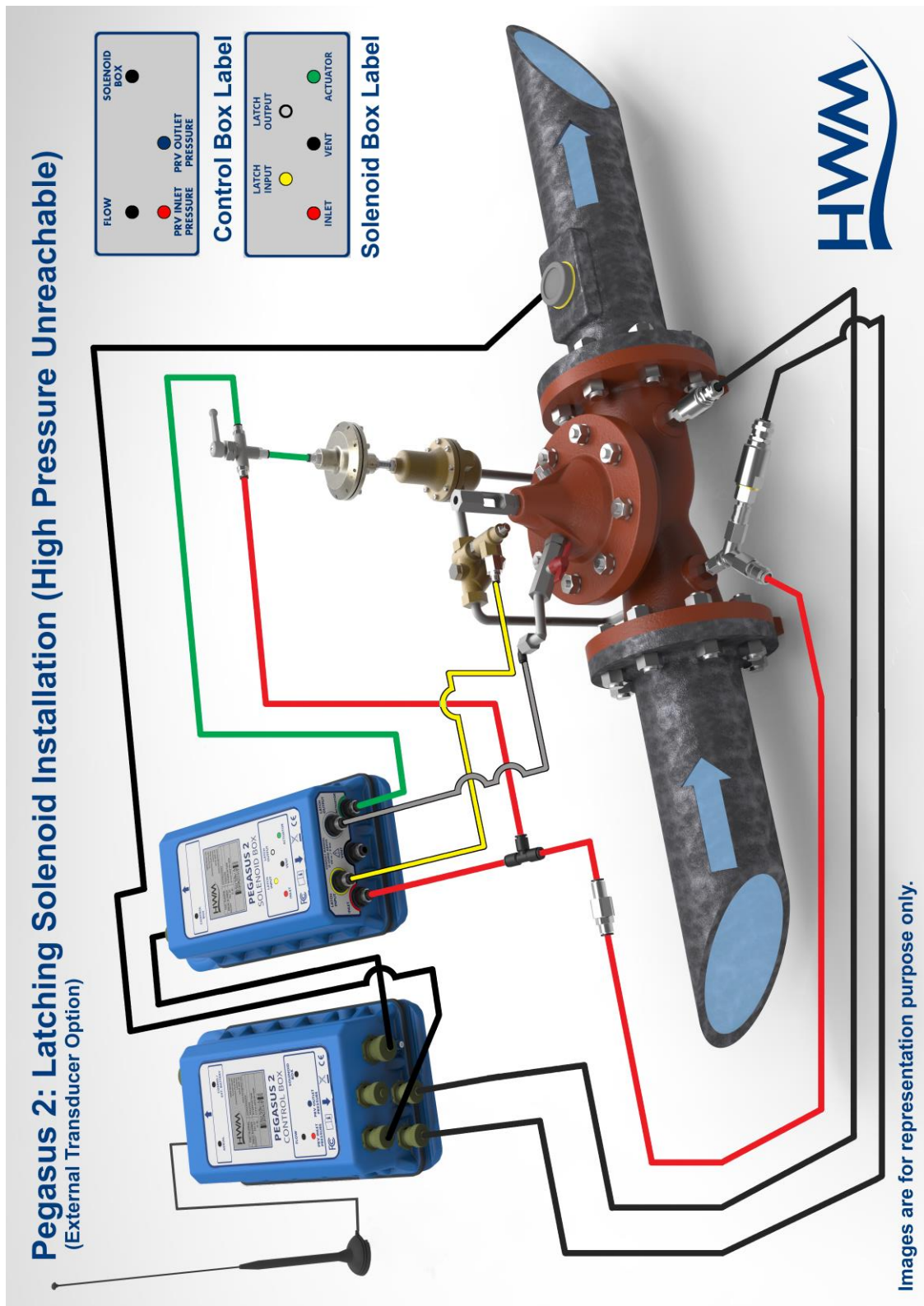

3.3.4 Using: Latch solenoid /external transducers (Pressure in > 90m)

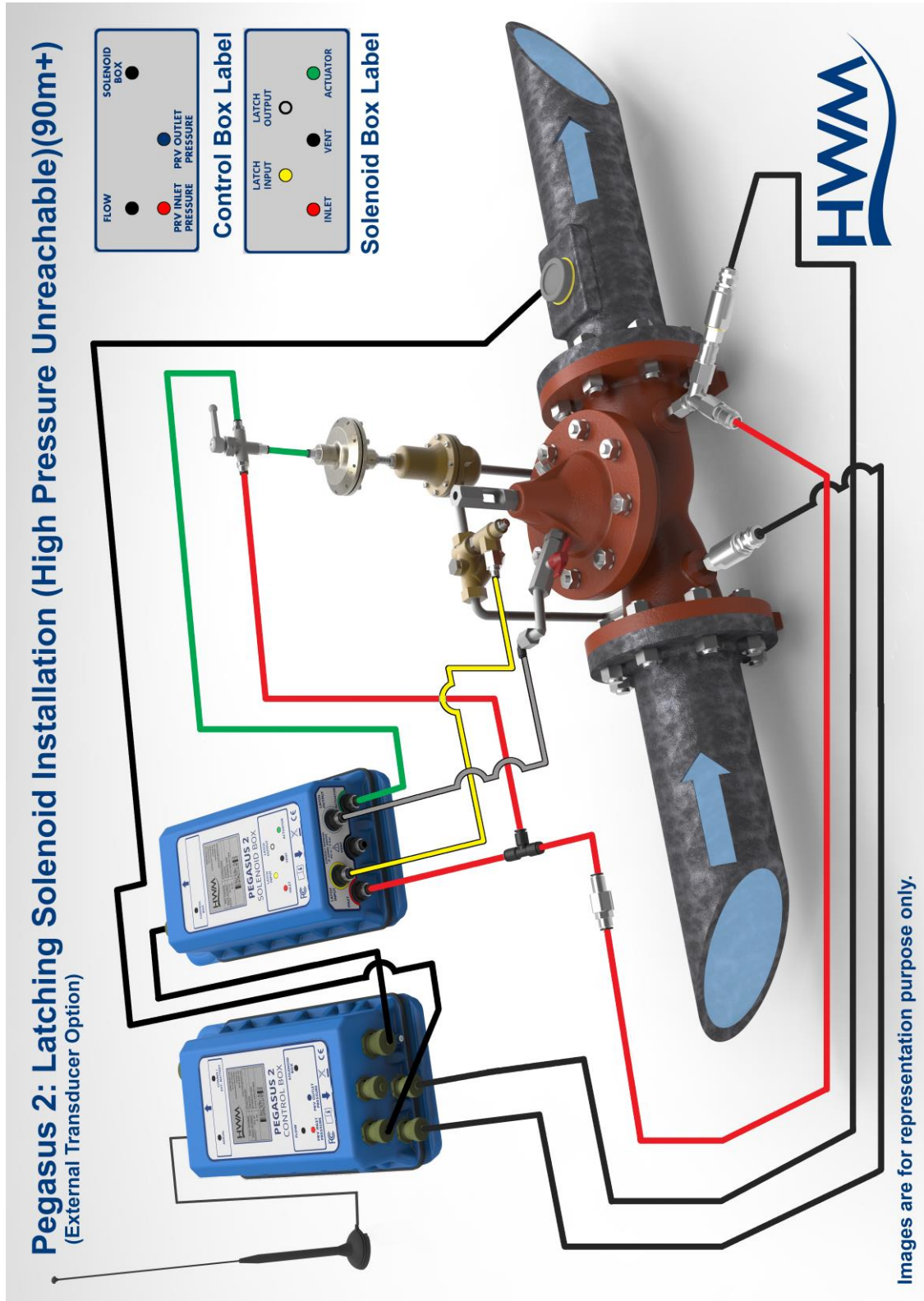

3.4 (OTHER INSTALLATION OPTIONS)

3.4.1 Models with additional Data Logging interfaces

Pegasus2 includes data-logger functions. It is able to monitor various (optional) transducers in addition to the (non-optional) pressure transducers. The interface for the transducer must be ordered by selecting the appropriate model part-number; it is fitted and enabled at the time of manufacture.

Refer to your sales representative for assistance if required.

For example, it may be required that an additional pressure transducer be fitted so that the pressure within the upper chamber of the PRV can also be monitored and logged.

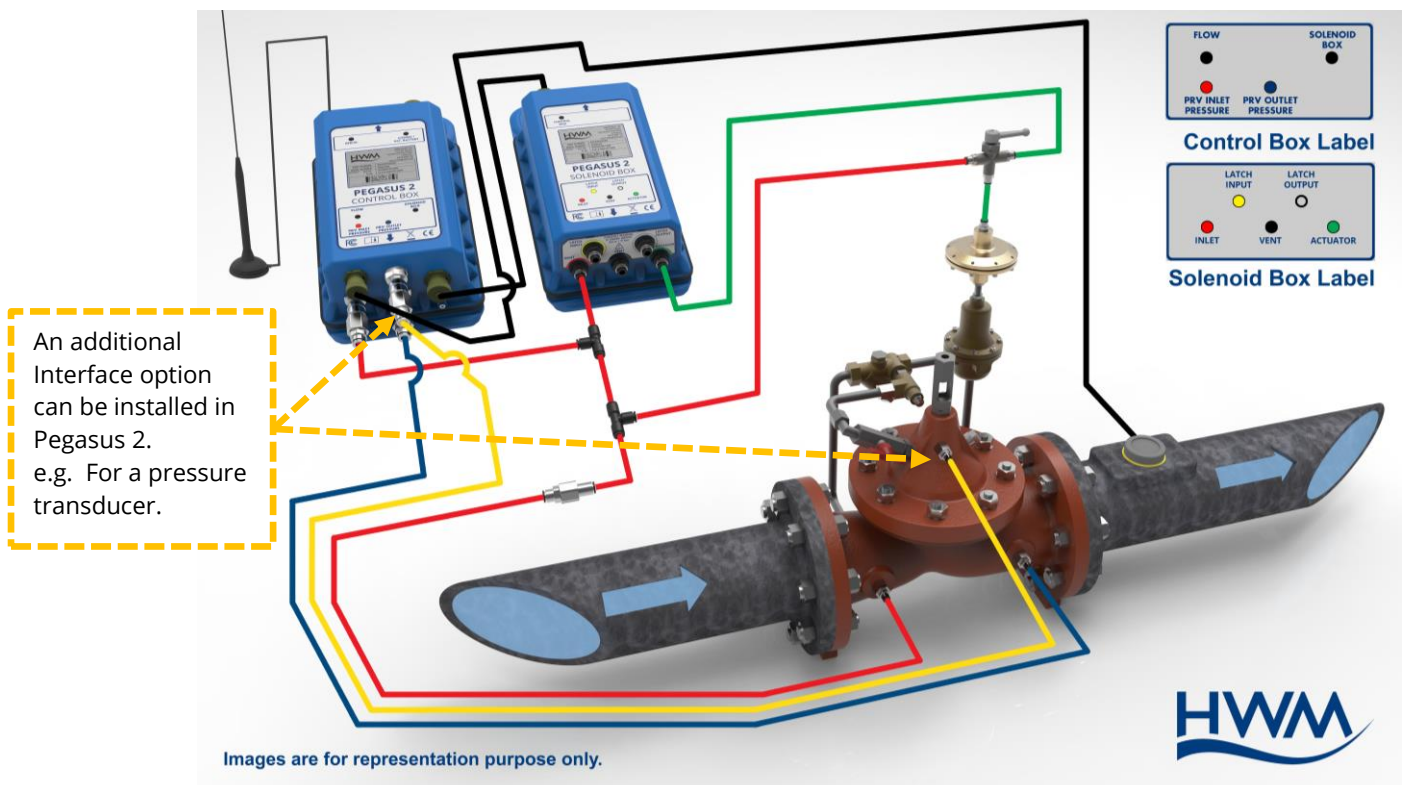

3.4.2 Control of two PRVs

Pegasus2 can be used to control certain installations that have two PRVs that are connected in parallel.

(Refer to section 6 for details of additional equipment and settings).

3.4.3 Configuration for timed supply / cut-off of water supply

The Pegasus2 can be used with modified plumbing and configuration to provide a regulated water pressure during certain times, but to also cut-off water supply during certain parts of the day.

(Refer to section 5).

4 INSTALLATION PROCEDURE (PEGASUS2 / STANDARD OPERATION)

WARNING: This equipment should be installed, adjusted, and serviced by qualified water industry maintenance personnel, familiar with the construction and operation of the equipment and the hazards involved. Failure to observe this precaution could result in damage to the water network.

The installer should become familiar with the use of IDT as it is used at various parts of the installation process. (e.g. It is required in order to bleed air out of the system, test Pegasus2 operation, and program a pressure profile).

Standard operation is described in sections 2.12.4 and 2.12.5.1.

It requires the 'System is connected to allow valve to be fully closed' control to be set to disabled (un-ticked or No), as shown below.

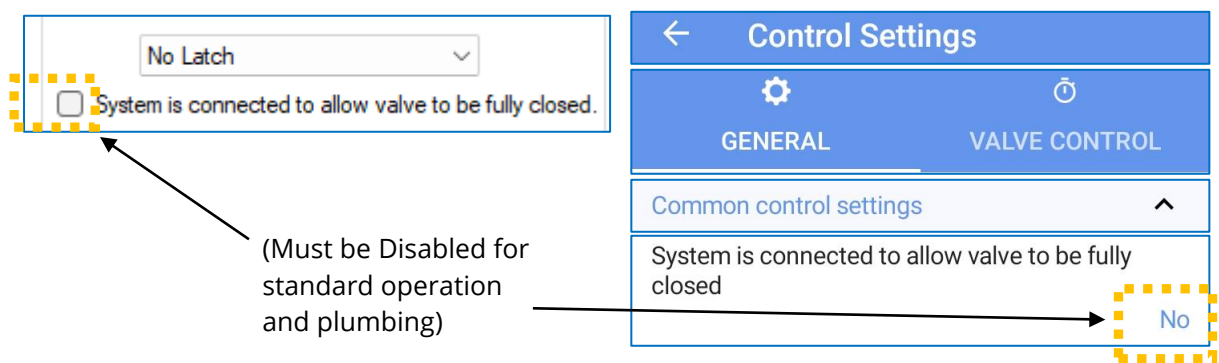

Summary of system selection and Installation:

The system can be fitted to an operating PRV, however some flow pressure variation will be experienced whilst testing the system. Installation consists of various activities including:

- Choose a Pegasus2 system with suitable Control Box and Solenoid Box units (model numbers) for the PRV being controlled and monitored.
 - Pressure measurement transducers must be suitable for the pressure range of the PRV upstream and downstream pressures.
 - The interface for Flow measurements must be compatible with the flow meter.
 - To log additional parameters, select a model with additional interfaces.
 - Determine what the system should do when a fault is detected, or the output pressure is unachievable. Select a model with an internal latch if required.
- Determine the most appropriate control method for the PRV (time, flow or combined time and flow).
- Select an appropriate connection scheme for the PRV and ensure pipes and accessories are available; Refer to the example installation diagrams within this guide.

Confirm the Pegasus2 is set up for standard operation and plumbing (see diagram of IDT settings, shown above).
- Choose suitable positions and mounting method for the equipment including the antenna; Fix in location and connect any cables.

- Attach a communications cable between Control Box and PC for set-up of the system.
- Program the required pressure profile and other settings into the Pegasus.
 - Read the current configuration.
 - Make any changes required to the on-screen settings.
 - Program the Pegasus with the on-screen settings.
 - Re-zero pressure transducers at atmospheric pressure (not water pressure).
- Fit the mechanical actuator onto the PRV pilot. Set the range of the actuator (required mechanical adjustment) to maximum and minimum required pressures.
- Plumb the Pegasus system into the PRV. Connect transducers.
- Activate the Pegasus to begin logging measurements and controlling the PRV.
- Test the operation of the system.
- Test communication with the central computer is OK (i.e. a call-in test).

4.1 POSITION CONTROL AND SOLENOID BOXES / LINK WITH CABLE.

The Pegasus2 Control Box and Solenoid Box can be secured to a wall using optional brackets, shown opposite. Ensure the wall and fixings used are able to bear the weight of the Pegasus2 and any cables.

All cables should be routed and secured in a way that avoids stress being put on the connectors.

4.1.1 Antenna

The bracket offers just one potential mounting location for the antenna, as shown.

The antenna will be connected to the connector labeled "Aerial". However, choice of a suitable antenna, preparation for use, and the process of finding an optimal location for the antenna within the installation is a topic in its own right. (See section 4.25 for details).



4.1.2 Battery

If the system is to be installed with an external battery (optional, but sometimes required to increase the length of service of the system), mount it in a suitable location near the control box. It must be connected to the Control box via the connector labeled "Comms / Ext battery".

The external battery may be temporarily disconnected during parts of the installation (whilst the Comms cable is required to be used) but must be re-connected at the end of system installation.

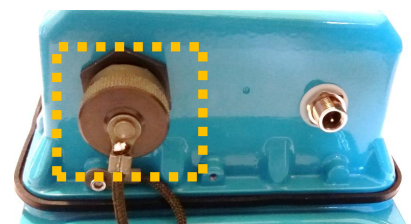
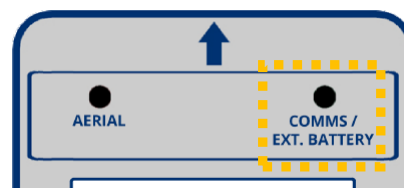

4.1.3 Interconnection Cable

Connect the Control box to the Solenoid box using the 6-way Pegasus2 interconnector cable (p/n: CA-163-0004-* / length).



4.2 CONNECTION TO THE FLOW METER

Connection to the flow meter is required for any Pegasus2 that uses a pressure profile that is dependent on flow (i.e. flow or combined time and flow).

For other situations it is optional, and will be used only by the data-logger functions.

The water flow can be detected by a flow meter near the PRV. The Flow information is transferred to Pegasus2 by means of an electrical interface in the Control Box.

Various hardware interfaces exist for collecting flow information, including:

- Collection of meter pulses (from a contact or a volt-free pulse output). This type of interface is suitable for supporting the PRV control functions. (Refer to section 8.1.1 for cable diagram).
- Analogue (4-20mA) input for connection to a compatible output of a flow meter. This type of interface is **unsuitable** for supporting the PRV control. It can be used as a logger interface option only.

Connect the Flow-meter end of the cable to the flow meter.

Then connect the cable to the Control box via the connector labeled "Flow".



Note: Once the flow meter input has been set up using IDT, the flow rate can be tested using the same screen as used for testing pressure sensors (see section 4.11).

4.3 CONNECT EXTERNAL PRESSURE TRANSDUCERS TO PEGASUS 2

Where the Pegasus2 is supplied with *external* pressure transducers, these must be connected to the relevant MIL-spec connector on the control box.

Determine which transducer will be used for measuring upstream pressure and which will be used for measuring downstream pressure. Check the range of each transducer is suitable for use (refer to the label on the cable of HWM supplied external transducers, as described in section 4.4).

Plug each transducer into the correct Pegasus2 MIL-spec connector:

- Be sure to connect the upstream pressure transducer to the connector labelled "PRV Inlet pressure".
- Be sure to connect the downstream pressure transducer to the connector labelled "PRV outlet pressure".

Ensure connectors are correctly fitted so that they are watertight.

4.4 CHECK / MODIFY PEGASUS2 CHANNEL SETTINGS

For Pegasus2 to operate, the input channels must be set up, along with any calibration data and also various other settings. These inform the unit of what type of transducers are attached and how to interpret numeric readings into accurate physical measurements.

Pegasus2 channels must always be set to use the following units of measure:

- Pressure: meters ... although inputs work in raw units of decimeters (1/10 m).
- Flow: liters per second.

For Pegasus2 to operate correctly, (including use with the DataGate and PressView websites), the unit must always be set up with data presented to the built-in logger using the following channels:

- Channel 1: PRV inlet pressure (upstream pressure).
Pegasus uses the "Pressure 1" type of interface in IDT for this connector.
- Channel 2: Flow.
Pegasus uses one of a set of interface types for this connector.
Each interface expects a voltage-free pulse output from the Flow meter.
 - Flow Bi (for a Bidirectional Flow meter)
 - Flow Uni (for a Unidirectional Flow meter)The unit counts meter pulses (fluid consumed) over a logged period (time) and converts the values into a "liters per second" measurement.
- Channel 3: PRV outlet pressure (downstream pressure).
Pegasus uses the "Pressure 2" type of interface in IDT for this connector.

The diagrams below show a summary of channel settings required on Pegasus2. The transducers are shown as inputs to a data-recorder which has several channels of recording memory. (They are arranged as a set of "logging channels").

Logging Channels	
1	Pressure1, Pressure (m), Multiplier: 0.1, Ave 
2	Pulse/Flow Bi, Flow (l), 1 l per pulse, Ave 
3	Pressure2, Pressure (m), Multiplier: 0.1, Ave 

Logged Channels	
1	Pressure1 - Pressure (m) Multiplier: 0.1 - Average
2	Flow Bi - Flow (l) Units/Pulse: 1 - Average
3	Pressure2 - Pressure (m) Multiplier: 0.1 - Average

i.e., Channel 1

- Must use the Pressure1 interface.
- It must interpret the numeric data as Pressure.
- The recording unit must be set to 'm'.
- The input multiplier must be set to 0.1 for internal pressure transducers. (Calibration factors are applied in production such that each digit change represents a decimeter (1/10m) of water pressure change. Or, put another way, the number obtained when the interface is read has to be multiplied by 0.1 to convert it to meters (m, the selected recording unit)).
- Offset is set to 0.

Channel 2

- Must use the Flow Bi interface or the Flow-Uni interface; These may be shown as Pulse/Flow-Bi or Pulse/Flow-Uni on IDT.
- It must interpret the numeric data as Flow.
- The recording unit must be set to 'l' (i.e., liters).
- The Units per Pulse must use the appropriate meter factor to convert the site's meter pulses to liters.
 - e.g. (1) If 1 pulse represents 10 liters, "Units per pulse" should be set to "10".
 - (2) If 1 pulse represents 1 UK gallon, "Units per pulse" should be set to "4.54"; (This is the number of liters per 1 UK gallon).

Channel 3

- Must use the Pressure 2 interface.
- (All other settings must be set in a similar manner to Channel 1).

The "Logging Mode" of all channels should be set at "average" for Pegasus2; this will smooth-out any noise (short fluctuations) in the readings and give a representative value of pressure.

Note: The pressure range can be found from examination of the model number for internal transducers, or a calibration details label on the cable of external transducers supplied by HWM.

The steps required for setup (or checking) of each of the logged channels is similar in nature to certain HWM loggers (e.g., Multilog2) and are described in the IDT user-guide; **Refer to the user-guide appropriate to the version of IDT you are using** for details (see section 1.6).

Note: The channels may be pre-configured by the factory prior to shipment, but **the installer is responsible** for confirming the settings are correctly configured to suit the installation site.

Ensure the channel settings are stored when finished.

External Pressure Transducers – Entering Calibration coefficients

External pressure transducers from HWM have calibration coefficients (usually located on the cable).

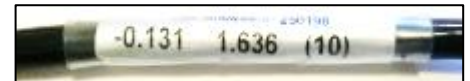

Note: The final number represents the *maximum pressure range* of the transducer, in bar.

The coefficients must be entered into IDT in order for Pegasus2 to use the pressure transducers correctly and obtain accurate measurements.

Enter the values, as per the examples shown below (including any negative symbols).

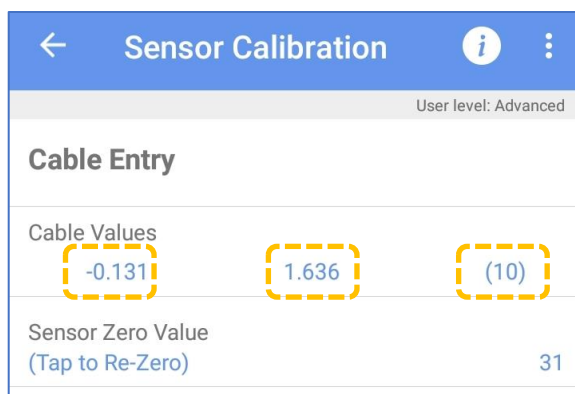

Note: Only one channel shown (above); repeat entry process for additional channel(s)

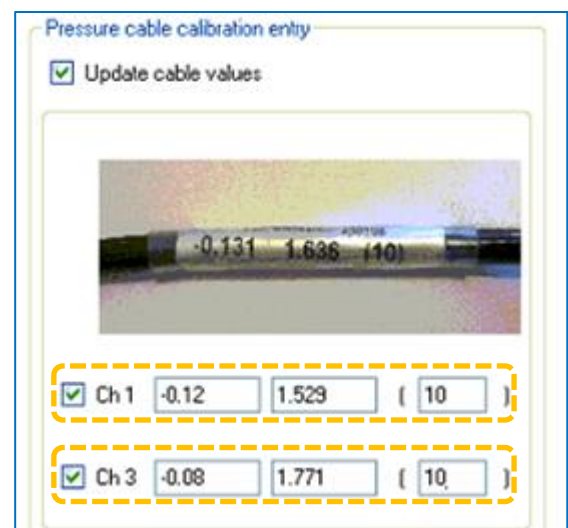

(Refer to the IDT user-guide for the required steps to do this).

At this stage, it is important that the channel settings stored in the PC memory should be written into the Pegasus2, and the device restarted. (Use the 'Setup Device' button in IDT (PC version); the IDT app will automatically save and restart at the appropriate time).

(The unit will now operate with the channels as set earlier).

4.5 RE-ZERO PRESSURE TRANSDUCERS

The transducers (**internal or external**) must now both be re-zeroed whilst in **atmospheric pressure**. (Refer to the IDT user-guide for the required steps to do this).

Note: During this operation, the sensors must be electrically connected, but **must not be connected to water pressure**.

To verify the transducers are re-zeroed, whilst still in atmospheric conditions:

Select the PRV Installation tab and click on the “Live values” button.

The Upstream and Downstream pressure values should now read zero, or very close to zero.

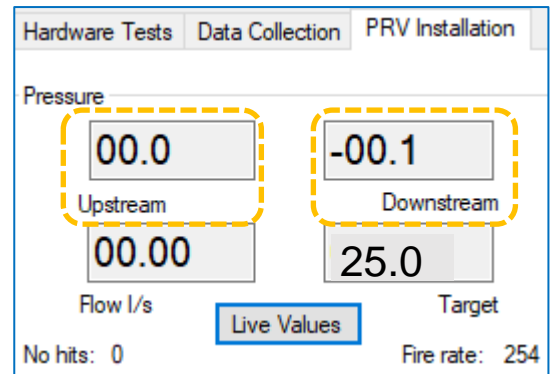

(Some additional information about the internal operation of the equipment is shown here: - 'No hits' is the duration (in seconds) that the target pressure has not been achieved.

- 'Fire rate' is the time between solenoid fires).

... Click the “Stop” button to end the verification.

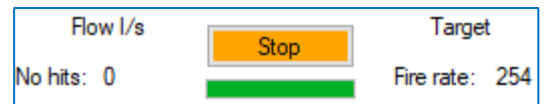

IDT App users:

For – Check of Live Values of pressure transducers

Equivalent controls are located as follows:
(main) → Test Device → PRV Installation.

Tap the Live Values / Stop button to start and end the display of live Pressure and Flow values.

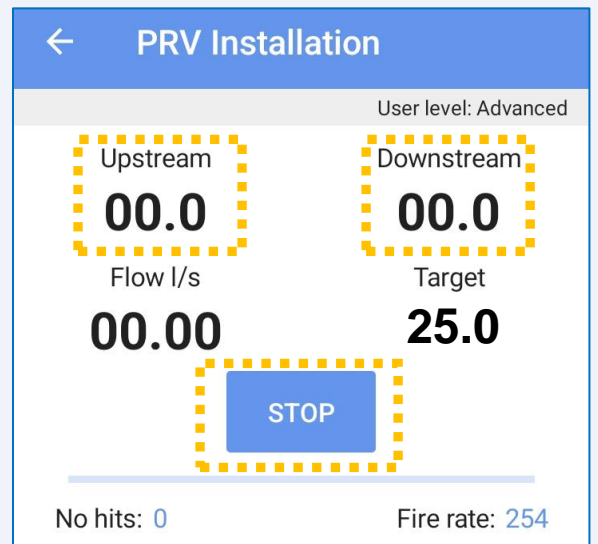

4.6 PREPARE THE PIPEWORK FOR THE PEGASUS2

Accessory kits which include colored hoses are available from HWM (ACT00* series accessory kits); Colored hoses makes identification easier. A manual 3-way valve and quick-connect fittings are also available. The standard ACT002/STD kit is shown below:



Use the installation diagrams to select the type of installation required:

- Standard installation where inlet pressure to PRV is less than 90m.
(Refer to diagram in section 3.2.1 for use with internal pressure transducers).
(Refer to diagram in section 3.2.2 for use with external pressure transducers).
- Standard installation where inlet pressure to PRV is more than 90m.
(Refer to diagram in section 3.2.3 for use with internal pressure transducers).
(Refer to diagram in section 3.2.4 for use with external pressure transducers).
- Standard installation for using latching solenoid for high pressure unreachable where the inlet to the PRV is less than 90m.
(Refer to diagram in section 3.3.1 for use with internal pressure transducers).
(Refer to diagram in section 3.3.2 for use with external pressure transducers).
- Standard installation for using latching solenoid for high pressure unreachable where the inlet to the PRV is more than 90m.
(Refer to diagram in section 3.3.3 for use with internal pressure transducers).
(Refer to diagram in section 3.3.4.3.2.4 for use with external pressure transducers).

Refer to the relevant diagram and cut the colored pipe to the required lengths.

4.7 PREPARE THE PRV FOR PEGASUS PRESSURE TRANSDUCERS

The PRV valve should be fitted with service taps that allow maintenance whilst the PRV is in operation.

An example is shown opposite.

Choose locations to be used for attaching the Pegasus pressure transducers and also the water feed to the Pegasus "Inlet" port.

Ensure these service taps are closed to allow work to proceed.

Fit Y-adaptors or quick-release connectors to the PRV, as required, to allow connection to Pegasus2 at a later stage.

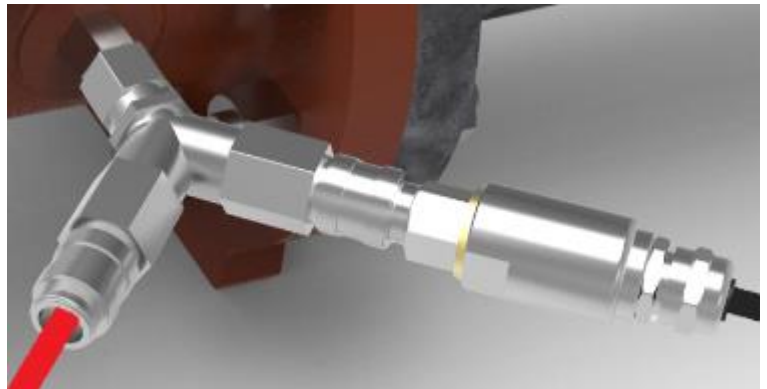
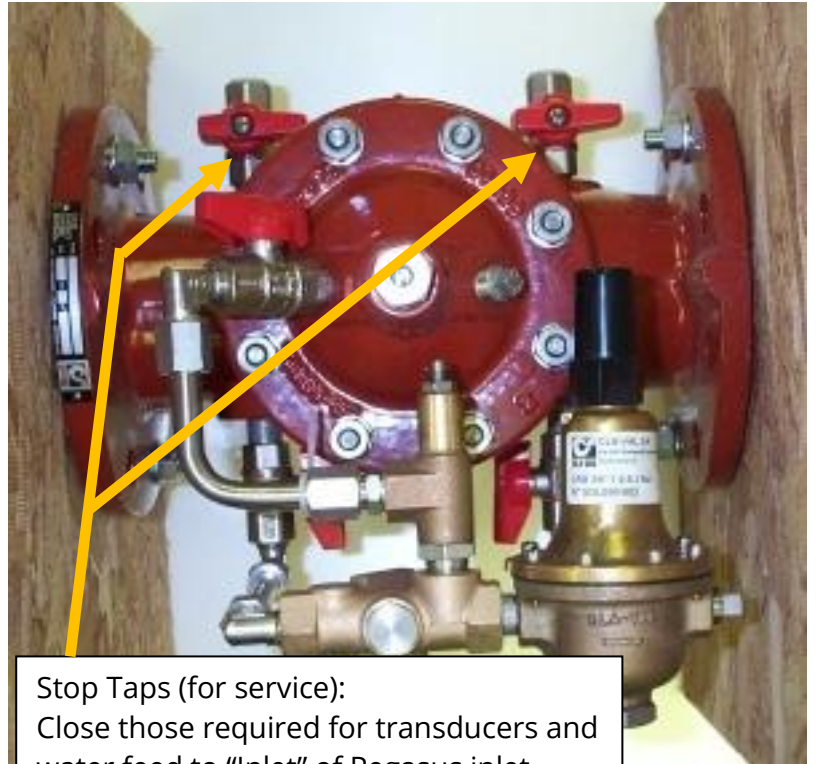

Do not fit any pressure transducers or hoses to the PRV at this stage.

4.8 CONNECT PEGASUS2 SIDE PIPEWORK

Pipes can be connected directly to the Pegasus2 Solenoid Box ports by pushing the end of the pipe into the port.

The pipes will be sealed and retained by the connector (until they are manually released, which requires pushing on the connector's ring whilst pulling the pipe away from the connector).



Where the Control box has internal pressure transducers, a quick-release adaptor is required to be fitted to the pipe-end before it can be attached.

Fit the adaptors to the end of the pipes (as required) and attach to the Control box.



Fit any T or Y adapters that may be required.



Attach all 3 the pipe ends to the manual 3-port valve.

Attach the pipes from the 3-way valve to the Pegasus, but do not yet attach the pipe to the actuator.

Make sure the 3-way handle is pointing to the green control pipe (shown).

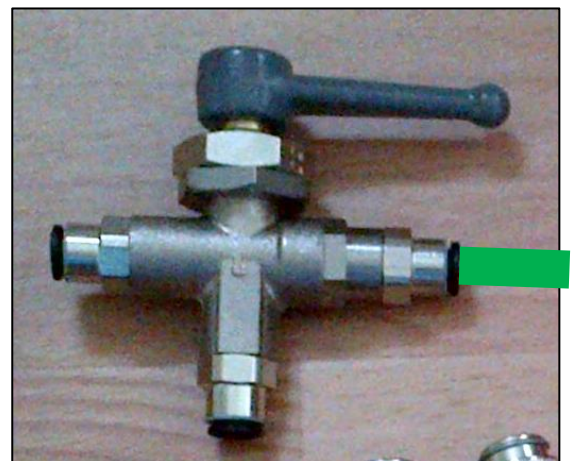

If required, attach a pipe to the port labeled "VENT" and route it to a suitable drainage site.

4.9 CONNECT TRANSDUCERS AND BASIC CONTROL PIPEWORK ON PRV SIDE

Before proceeding, confirm that the pressure transducers are of a suitable pressure range, that the channels have been set up, and the transducers have been re-zeroed at atmospheric pressure. (Refer to section 4.5).

Connect any **external** pressure transducers to the appropriate location on the PRV valve, ensuring that:

- The upstream side is connected to the “PRV Inlet Pressure” connector.
- The downstream side is connected to the “PRV Outlet Pressure” connector.

Connect any **internal** pressure transducers, by attaching the pipe quick-release connector to the appropriate location on the PRV valve.

- Ensure the upstream side is connected to the “PRV Inlet Pressure” transducer.
- Ensure the downstream side is connected to the “PRV Outlet Pressure” transducer.

If not already attached, connect the water feed to the Solenoid box “Inlet” port. The water feed should come from the inlet side of the PRV if the pressure is below 90m; otherwise, the water feed should come from the outlet side of the PRV (which has a reduced pressure).

4.10 BLEED AIR FROM THE PIPEWORK

Open **only 2** of the PRV service valves:

Valves that connect water pressure to the 2 (internal or external) pressure transducers.



Open 2 service valves
(to internal transducers)



Open 2 service valves
(to external transducers)

Where internal transducers are fitted, detach and then re-attach the pipes using the quick-release connectors at the Pegasus2 side (several times). This will allow air to escape from the pipes via the quick-release connector and be replaced by water.

Use the manual controls within IDT to bleed air out of the pipework:

Ensure control is de-activated (click on No-Control button if required).

Within the Manual Adjustments panel, click on the “Up” button several times to pulse the solenoid valve inside the Pegasus2, allowing air and water to pass through the unit and fill first the red pipe (entering Pegasus) and then the green pipe (leaving Pegasus).

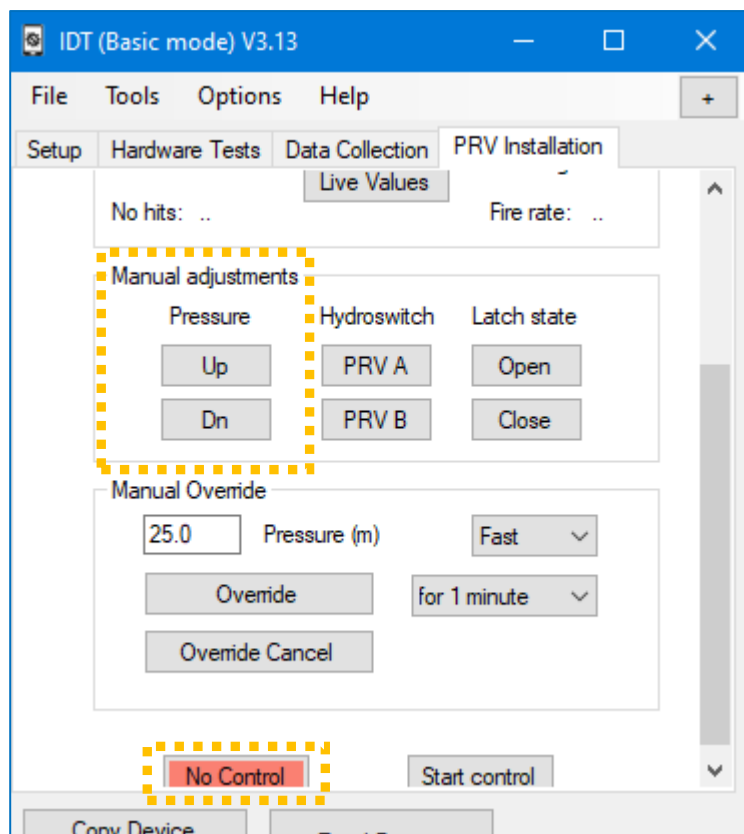

IDT App users:

Equivalent controls are located as follows:
(main) → Test Device → PRV Installation.

If required, tap the Manual Adjustments line to reveal the Pressure Up and Down buttons.

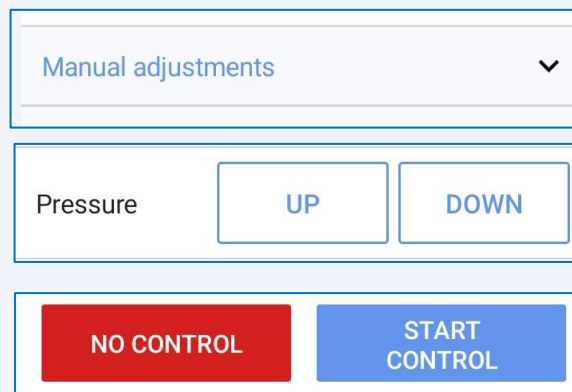

4.11 TEST PRESSURE TRANSDUCERS

Select the PRV Installation tab of IDT.

Click on the “Live Values” button.

The display will show readings for the following:

- Upstream Pressure (in meters)
- Downstream Pressure (in meters)
- Flow (in l/s)

Confirm the values are as expected.

Click the button once more to stop displaying the readings.

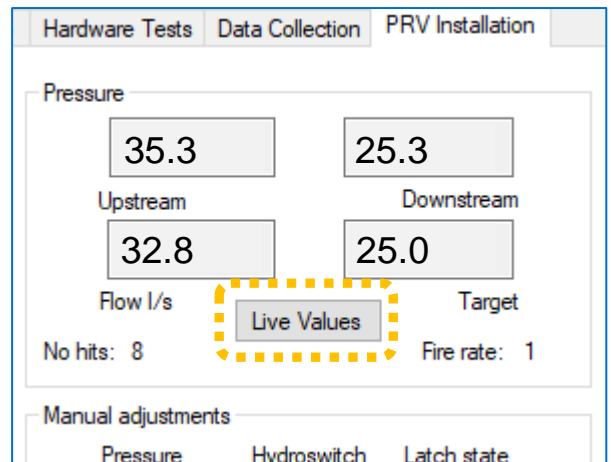

IDT App users:

For – Check of Live Values of pressure transducers
Equivalent controls are located as follows:
(main) → Test Device → PRV Installation.

Tap the Live Values / Stop button to start and end the display of live Pressure and Flow values.

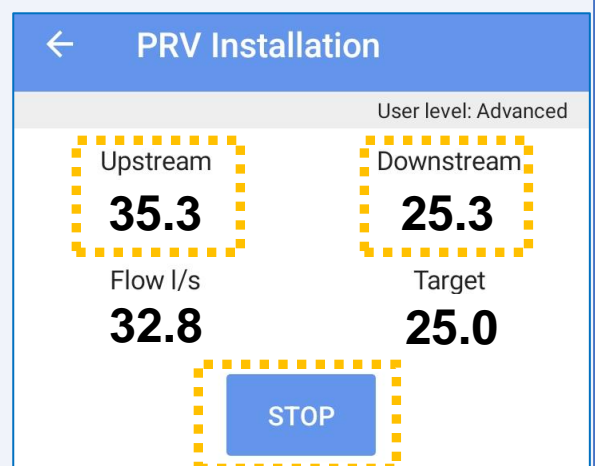

Note: Where the unit has been set up with a control method and target pressures (see later), the live values display also shows the current target pressure.

4.12 PREPARING TO FIT THE ACTUATOR

Note: The following instructions assume that the valve is neither vented to the maximum (fully open), nor used to cut the water supply (fully closed) but is under the control of the fitted pilot valve.

It also assumes that the PRV is fitted with service stop-taps at the relevant ports on the valve, allowing the components surrounding the main valve to be serviced.

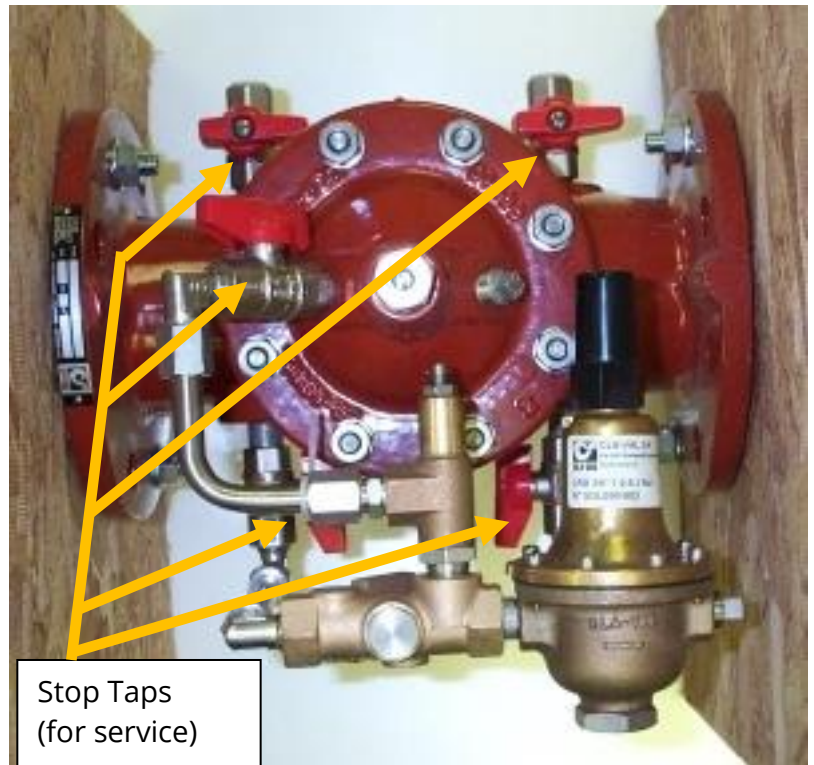

Ensure that the PRV is working properly before proceeding.

Lock the PRV top chamber by closing the valve to the top chamber, if possible.

If your PRV has taps on the pipe rail, shut both the input and output path of the pilot valve together (at the same time).

This will ensure that the volume of water contained in the pilot valve will remain constant; its diaphragm is locked in position.

Close PRV top chamber valve

Simultaneously close the input and output path to the pilot valve

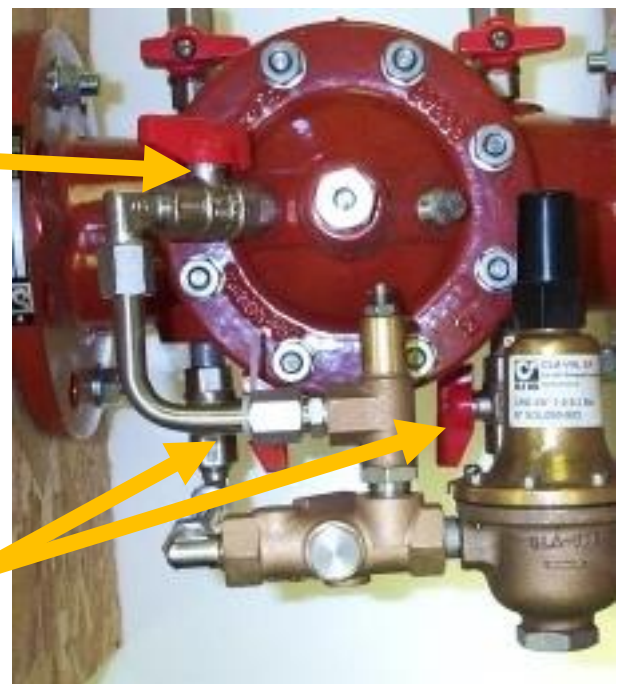

Note: The upper chamber of the PRV valve is now locked in position. The output pressure is not regulated, and any variations in inlet pressure will affect the output pressure

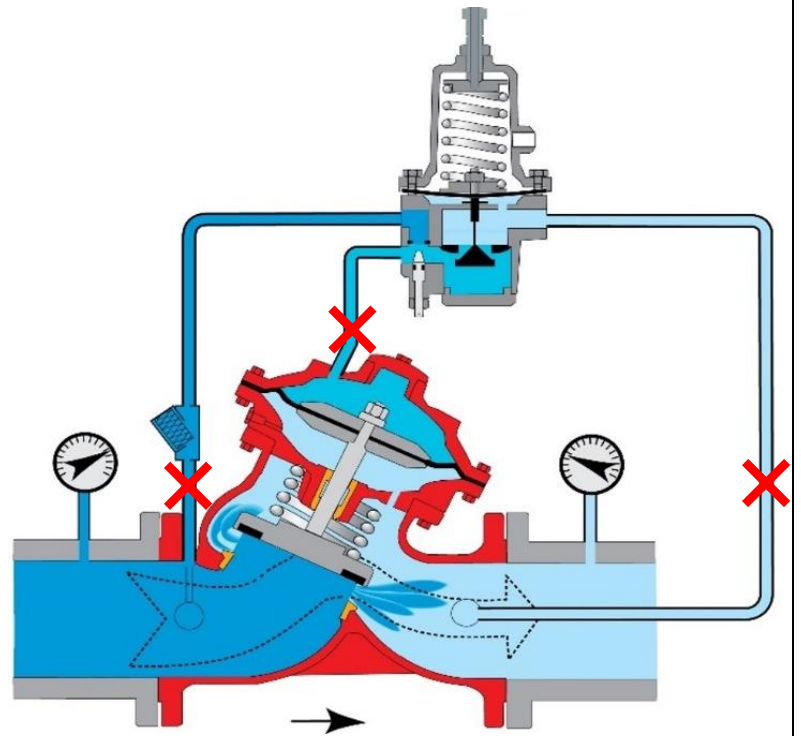

4.13 FITTING AND ADJUSTING THE HWM MECHANICAL ACTUATOR

Ensure that the thread of the HWM mechanical actuator being used is the same type of thread as the existing adjustment bolt on the PRV pilot valve. (HWM can supply alternative threads if the actuator is unsuitable).

Screw the top nut and bottom nut towards the middle nut until it is finger tight, so that they are together (see picture).

Screw the actuator thread into the actuator head until it is finger tight. (Use the middle nut).

This moves the plunger to the top of the inside of the actuator upper chamber. The pin (lower part of the plunger) should now be fixed.

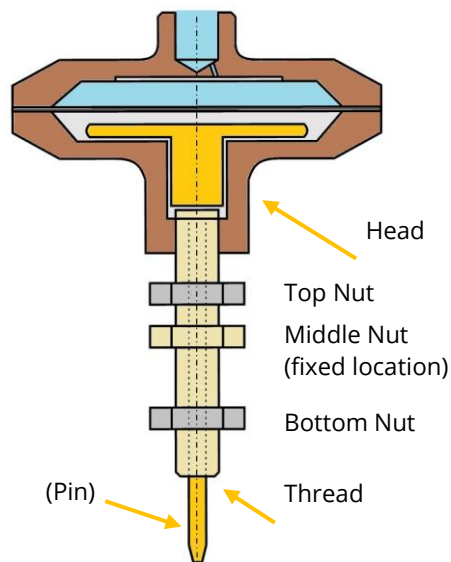

Note the depth into the pilot valve of the existing bolt. Also note the force required to turn it at that position.

Unscrew and remove the existing PRV pilot adjustment bolt. (see picture). Check the outlet pressure reading whilst removing the bolt; the pressure should not change. If pressure drops at this point a valve is leaking.

Note: Use the Pegasus transducers and IDT to help set the actuator pressure settings.
(See section 4.11).

Screw the HWM mechanical actuator into the pilot of the PRV.

It should be positioned at approximately the same depth as the pilot bolt, which has just been removed.

Rotate the actuator to apply the same force that was applied by the (now removed) adjustment bolt.

Open both the input and output path of the pilot valve together (at the same time, if closed).

This will permit water to flow through the pilot valve; its diaphragm is no longer hydraulically locked in position.

Slowly open the PRV top chamber valve. The PRV will now return to pilot control, influenced by the actuator pin position.

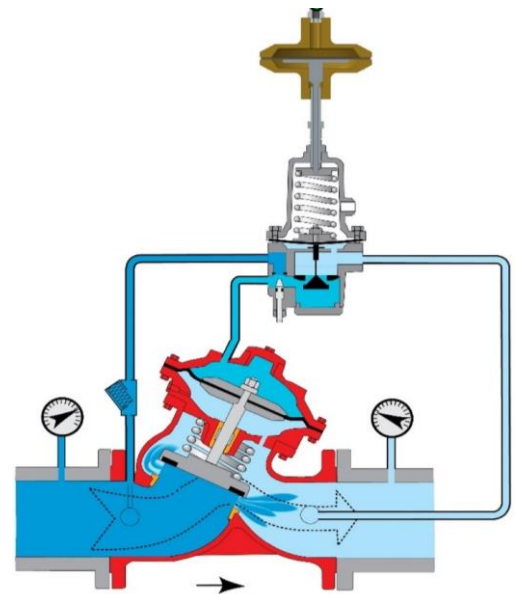

Whilst checking the outlet pressure of the PRV, **set the maximum pressure** required by adjusting the position of the **actuator bolt**.

To do this, use the middle nut (fixed) on the actuator thread:

- Screw it clockwise / inwards to increase the output pressure.
- Screw it anticlockwise / outwards to decrease the output pressure.

Note: The pressure is required to be set to a value of **2m above** the maximum pressure value used within the table of the profile that will be used to control the PRV operation.

Make sure you allow time for the PRV to settle its pressure after adjustment. (e.g. Wait for a few minutes and re-adjust if required).

Once the maximum pressure is achieved, tighten the bottom lock-nut on the actuator screw thread against the PRV pilot (see picture).

This will secure the maximum outlet pressure.



Whilst checking the outlet pressure of the PRV, **set the minimum pressure** required by adjusting the position of the **actuator head**.

To do this, hold the middle nut (fixed) on the actuator thread stationary, using a spanner, whilst rotating the actuator head.

- Screw it anticlockwise / outwards to decrease the output pressure.
- Screw it clockwise / inwards to increase the output pressure.

Note: The pressure is required to be set to a value of **2m below** the minimum pressure value used within the table of the profile that will be used to control the PRV operation. (e.g. Below night-time pressure)

Make sure you allow time for the PRV to settle its pressure after adjustment. (e.g. Wait for a few minutes and re-adjust if required).

Once the minimum pressure is achieved, tighten the top lock-nut on the actuator screw thread against the underside of the actuator head (see picture).

This will secure the minimum outlet pressure.



Insert the green pipe (which connects the 3-way manual valve) into the top of the actuator head (as shown).

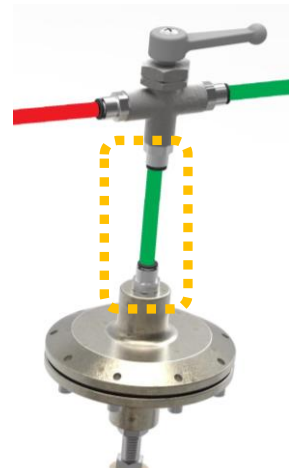

The Pegasus actuator is now installed. Any remaining air in the system will be dispersed as part of testing (see section 4.19).

4.14 LATCH OPTION - PREPARE THE PRV

(When installing Pegasus models that do not include a latch or do not require the latch to be used ... skip to section 4.19).

Lock the PRV top chamber by closing the valve to the top chamber, if possible.

Shut both the input and output path of the pilot valve together (at the same time).

This will ensure that the volume of water contained in the pilot valve will remain constant; its diaphragm is locked in position.

Close PRV top chamber valve

Simultaneously close the input and output path to the pilot valve

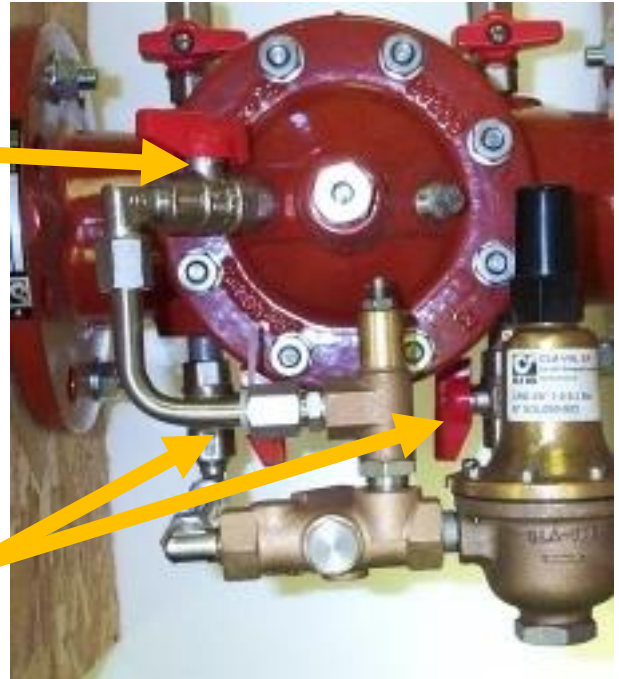

The two steps described above will allow work to commence on the pilot valve control pipework.

Note: The upper chamber of the PRV valve is now locked in position. The output pressure is not regulated, and any variations in inlet pressure will affect the output pressure.

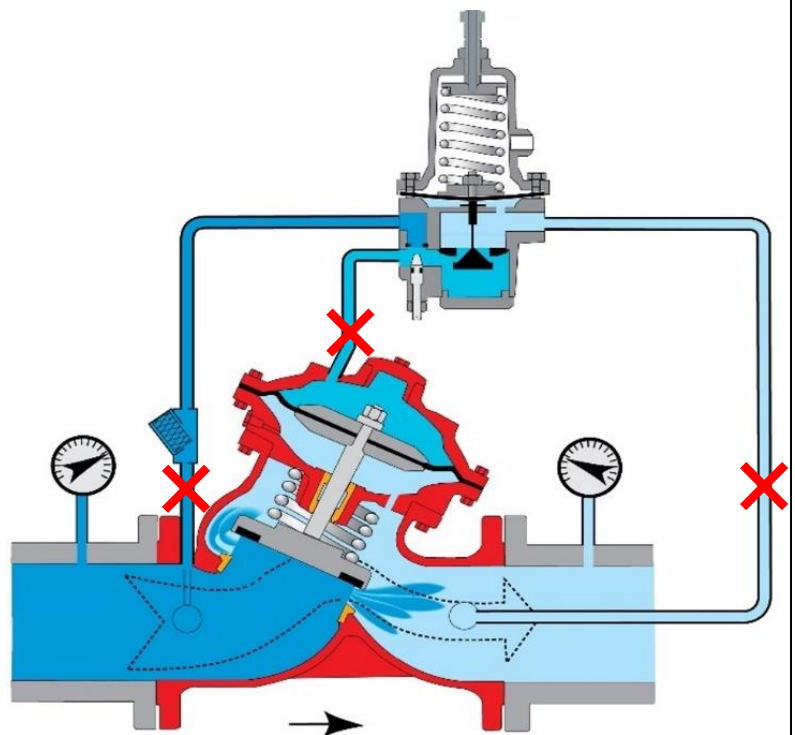

For a “Latch when high pressure unachievable” operation, the Pegasus Latch ports need to break into and control the path between the upper chamber of the PRV and the pilot valve, as shown in the illustration opposite.

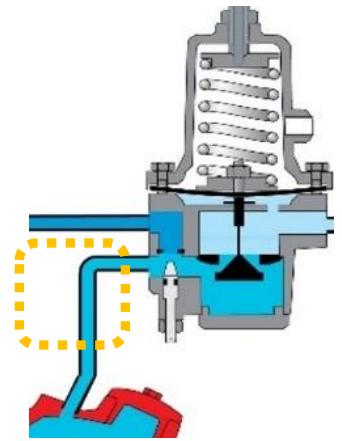

Dismantle the pipework on this part of the pilot control system and fix suitable adapters to receive the plastic pipes from the Pegasus2 latch ports.
(These are not supplied as standard).

4.15 LATCH OPTION - CONNECT LATCH PIPEWORK ON PEGASUS 2 SIDE

Cut the colored pipes (yellow and gray) to a suitable length and insert them into the Pegasus2 ports labeled “Latch Input” and “Latch Output” respectively.

Ensure any suitable couplings are added to the pipes for connection to the PRV and pilot valve connections.

4.16 LATCH OPTION - CONNECT LATCH PIPEWORK ON PRV SIDE

Fit the Pegasus2 latch pipework to the PRV and pilot valve connections; Refer to the relevant installation diagram for guidance.

4.17 LATCH OPTION – RE-INSTATE PILOT CONTROL / BLEED PIPEWORK

Ensure the Latch state is “Closed”, so that the pilot valve is not by-passed (refer to sections 2.12.5.1 and 4.18).

Open both the input and output path of the pilot valve together (at the same time). This will permit water to flow into and through the pilot valve, allowing it to re-fill.

Slowly open the PRV top chamber valve. The PRV will now return to pilot control via the actuator setting, but there will be air in the pipework between the upper chamber of the PRV and the pilot valve (and also within the latch circuit of Pegasus). This air will eventually disperse to down-stream during PRV operation. The air can also be removed during testing / exercising of Pegasus2, by temporarily increasing and decreasing the target output pressure. (See section 4.19)

4.18 LATCH OPTION - TESTING

Where fitted, facilities are available to manually test the latch (solenoid valve) option using buttons within the IDT tool. The latch can be opened or closed by the installer.

When plumbed into the upper chamber of the PRV, this will cause the PRV to switch between being regulated, under control of the pilot valve, or to bypass the pilot valve.

Caution: The installer should be mindful of the water inlet pressure **before manually operating the latch solenoid to by-pass the pilot valve.**

****** Ensure the downstream water network and any connected device can withstand the **increase in water pressure** before manually by-passing the pilot valve.

****** Ensure the outlet water pressure never exceeds the maximum specified pressure at any connection to Pegasus2 or of the sensors supplied.

(When correctly set up and running under automatic control, Pegasus2 will bypass the pilot valve only when the inlet water pressure is abnormally low (and the outlet pressure requires being slightly boosted). Alternatively, when configured for non-standard installation, this will be when the outlet water pressure is low (and a further reduction is desired)).

The latch circuit can be manually switched using the Open and Close buttons within IDT.

Note: The buttons will not be shown if the unit's control is set to "No Latch" (see section 4.20).

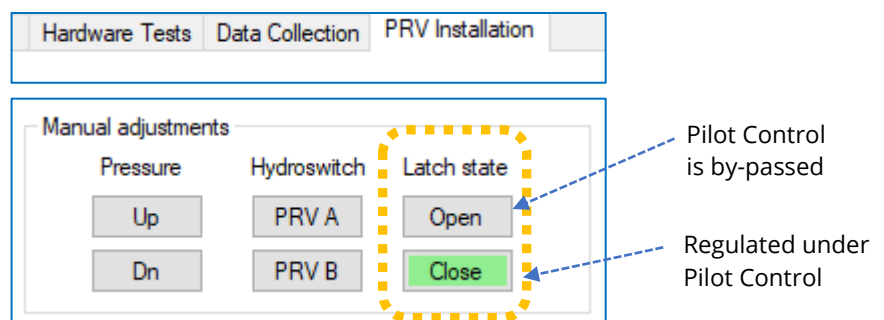

- The latch state of "Closed" is normal operation, with the PRV regulated under pilot control.
- The latch state of "Open" causes the pilot to be by-passed. The upper chamber of the PRV is connected to the Pegasus "Vent" port (with standard plumbing and operation), which allows the PRV to become more open. This causes an increase in output pressure.

IDT App users:

Equivalent controls are located as follows:
(main) → Test Device → PRV Installation.

(If required, tap the Manual Adjustments line to reveal the Open and Close buttons.)

Note: The Latch state buttons will not be shown if the unit's control is set to "No Latch" (see section 4.20).

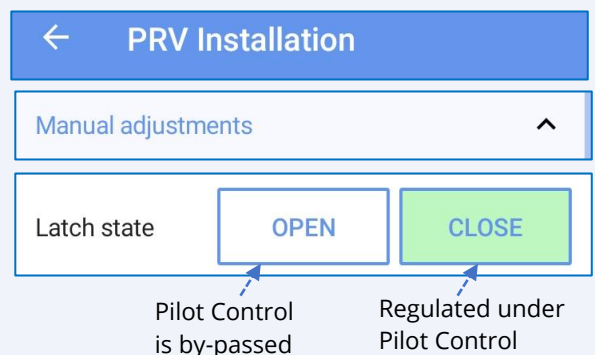

4.19 TESTING THE ACTUATOR (MANUAL OVERRIDE)

The actuator can be tested when the PRV controller is not running (see section 4.10). The actuator can also be tested whilst the PRV controller is running, by using the 'Manual Override' facility.

Note: Prior to testing the actuator, the Pegasus2 should have an initial control method and a few pressure targets set, so that the running PRV control has a target pressure to try to maintain. (See section 4.20).

To temporarily change the target pressure using the manual override section:

- Ensure the latch (if fitted) is in the Closed state to allow the PRV to be under the control of the pilot valve and Pegasus.
- If required, click on "Start control" and wait until the button turns green; the PRV controller is now activated.
- Enter the target pressure and duration in the manual override section.
- Click the "Override" button.
- Wait for the PRV output pressure to adjust and stabilise.
- To end early, cancel the over-ride.

There is a control to switch between "slow" (regular solenoid operation) and "fast" (accelerated solenoid operation) whilst the override is active. A "fast" setting may help to dispel any trapped air and speed up the test.

The actuator should be tested by switching between low, middle, and high pressures several times to ensure it is operating correctly. The system should move to the target pressure and stabilize. The pressure can be verified using an external pressure meter or by using the Pegasus2 transducers with IDT.

IDT App users:

Equivalent controls are located as follows:
(main) → Test Device → PRV Installation.

To use the Pegasus2 transducers, click the “Live Values” button. The display will update to show pressure and flow values. (Other buttons are disabled whilst this is operating; click on the “Stop” button to re-enable the other button controls).

If the target pressures are not achieved, check actuator settings and plumbing configuration before commencing further set up.

4.20 PRV CONTROL METHOD AND SETTINGS

Pegasus2 attempts to closely match downstream pressure with a current target pressure. The target pressure is set in a pressure profile, of which two types exist: Time control and Flow control.

Before considering how to enter and select profiles, a description is given of some common settings...

The output pressure of a PRV control is subject to some variation due to changes in output demand and also variations in upstream pressure. Even with pressure control these will result in variations in the outgoing pressure. Pegasus tries to adapt to changes and minimise the deviation from the current target pressure. The target pressure can also change from time to time (as defined in a target pressure profile).

Pegasus2 examines the current downstream pressure and compares it to the current target pressure every few seconds. Each time, it evaluates whether the actuator setting requires adjustment. Depending on how close output pressure is compared to the pressure target, it can either leave things as they are or change the volume of fluid in the actuator (by pulsing the up or down solenoids).

To overcome an excessive number of adjustments, a the “Deadband” field exists. This sets the tolerance that the output pressure is permitted to deviate from its target value and not require adjustment (+/- the entered value). This allows Pegasus to ignore minor temporary fluctuations in outgoing pressure. e.g. If the controller is trying to maintain an output pressure of 23m and the deadband is set to 0.5m, the controller will not make any adjustments between the pressures of 22.5m and 23.5m.

Where a change is required, Pegasus will pulse either the up or down solenoid. Each time it does this, it uses a small amount of power. If there are an excessive number of adjustments required per day, it can cause premature exhaustion of the battery. Pegasus monitors power use by solenoids does not exceed a limit. If the limit is exceeded, it will automatically adjust the Deadband limit (in 0.5m steps) so that it has to make fewer adjustments, thereby reducing power use. The adjustment of the Deadband continues until a level is found which results in an acceptable daily energy use. However, it does not do this without limitation; a maximum

Control Settings

Time control Flow control

Deadband 0.5 Auto Limit 8.0

No Latch

System is connected to allow valve to be fully closed.

Latch on unreachable duration (mins) 20

Use External Power When Available

limit can be set in the “Auto limit” field. Where the field is left blank, Pegasus2 defaults to a value of 8m.

IDT App users:

For – Deadband and
 – Auto Limit of Deadband
 Equivalent controls are located as follows:
 (main) → Configure Device → Control Settings
 → General tab.

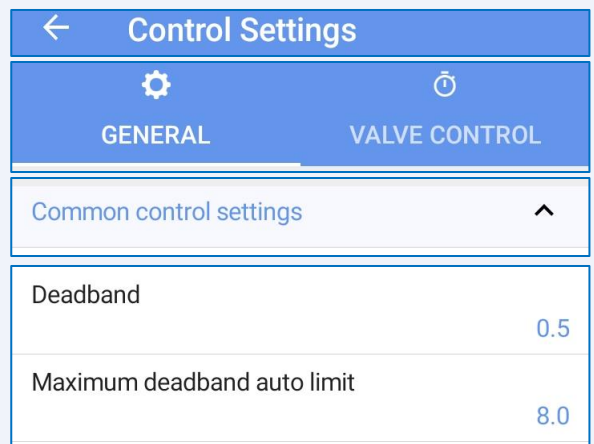

An area within the Control Settings panel defines which pressure profile tables will be used.

(These are discussed in sections 4.20.1, 4.20.2, and 4.20.3).

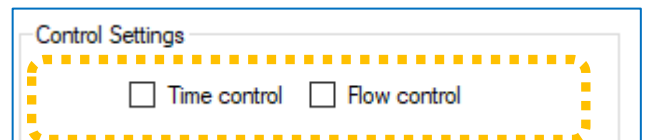

When neither Time control nor Flow control is selected (both are 'off'), the Pegasus2 automatic PRV controller (if running) has no defined outlet pressure target to aim for. It therefore suspends any attempt to change the current actuator setting.

When one (or both) control methods are enabled, additional settings are shown by IDT.

IDT App users:

Equivalent controls are located as follows:

(main) → Configure Device
 → Control Settings
 → General tab.

Tap the control line and make your required selection.

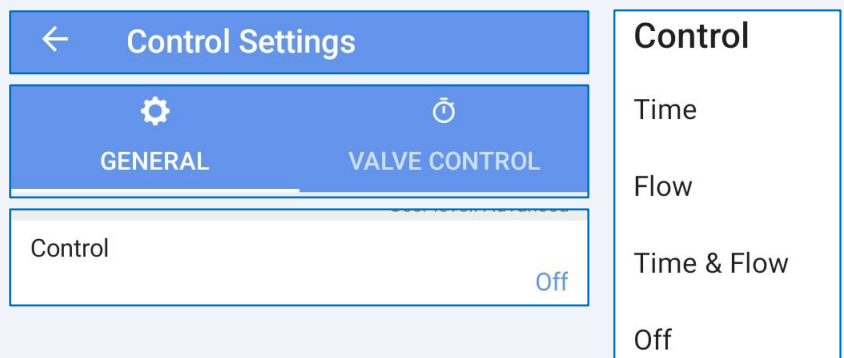

An area within the Control Settings panel defines the use of the (optional) latch solenoid valve. It can either be deactivated (as shown) or it can be set as to what type of event will trigger the latch valve to be activated.



Options are shown opposite.

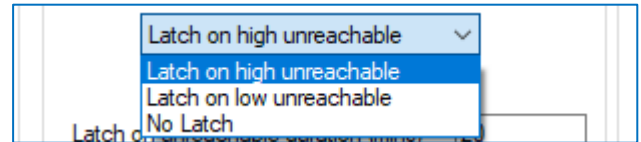

Caution: The setting you choose is dependent upon the desired behaviour of the system, which will also affect the way that Pegasus2 is plumbed into the PRV and its operation.

Certain settings and plumbing combinations can lead to **undesirable outcomes**.

Refer to section 2.12.3 for an explanation of 'high unreachable' and 'low unreachable'. Refer also to the description and applications identified in sections 2.12.4, 2.12.5 (and subsections).

Select the option that matches the required system behavior and plumbing.

The time period allowed for Pegasus2 to try to reach a target pressure can be adjusted using the "Latch on unreachable duration" setting. Enter the timer duration in minutes.

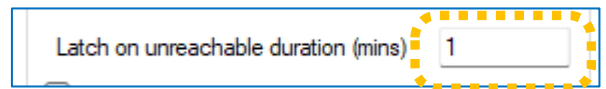

If Pegasus2 is unable to reach its target pressure for this duration of time it will then activate its latch circuit (to bypass control by the pilot).

IDT App users:

Equivalent controls are located as follows:
(main)
→ Configure Device
→ Control Settings
→ General tab.

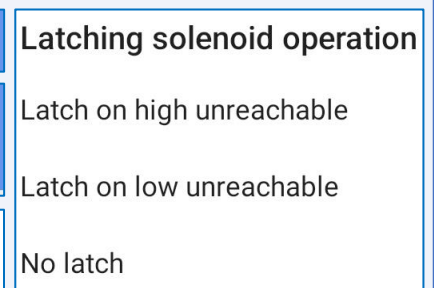
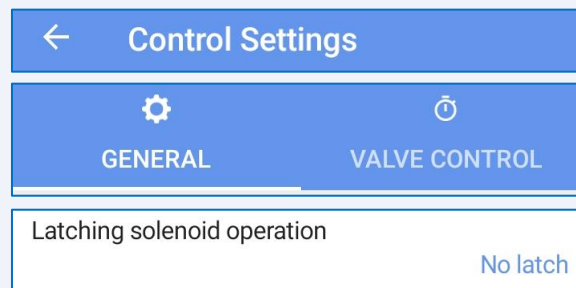

Tap the 'Latching solenoid operation' line and select the option required. (Refer to the Caution note, above).

The 'Latch on unreachable duration' (timer setting) is also located here.

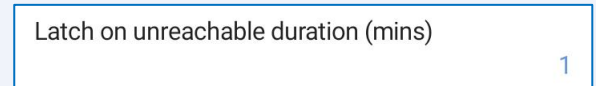

There is a setting called 'System is connected to allow valve to be fully closed'.

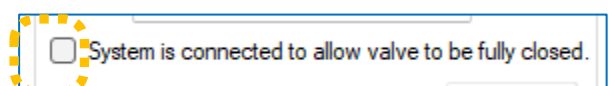

This is an important setting. It affects the operation of the internal valves inside the unit; it swaps over their use for controlling pressure up and down. It should be set according to the plumbing scheme used for installation of the Pegasus2.

In summary:

- Select 'un-ticked' (disabled) for any of the 'standard plumbing' schemes.
or
- Select 'ticked' (enabled) for the non-standard plumbing scheme.
(IDT will provide a warning, as ports within Pegasus2 are re-purposed and the user must confirm that the installation follows the non-standard plumbing scheme).

Caution: This setting is used only in very **rare** cases where the aim is to **cut off** the water supply during certain times of the day.

*** For more details refer to section 2.12.5 (and subsections). ***

IDT App users:

Equivalent controls are located as follows:
(main) → Configure Device → Control Settings
→ General tab.

Check the current setting.
If required, tap the line, and make the required selection.

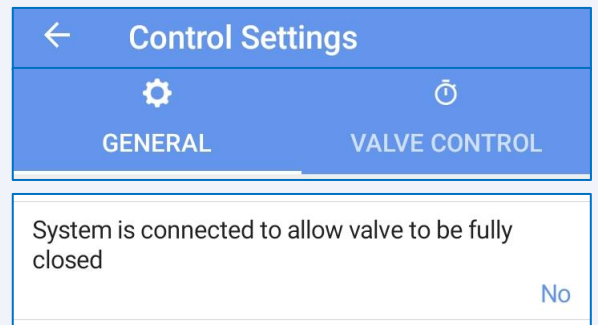

Once triggered, Pegasus2 will remain in a latched state until the outlet pressure changes (see below) or the target pressure itself changes.

- For **standard** plumbing and operation, 'Latch on **High unreachable**' setting:
Typically, the latch circuit activated because inlet pressure was low, but if it recovers such that the outlet pressure is at least **2m above** target pressure. Pegasus2 will de-activate the latch valve and resume control via the pilot.
- For **non-standard** plumbing and operation, 'Latch on **Low unreachable**' setting:
Typically, the latch circuit activated because the target pressure was set to be 0m during that part of the day. 'When the *target* pressure is increased (to resume water supply) the outlet pressure is now at least 2m below the target pressure. Pegasus2 will de-activate the latch valve and resume control via the pilot.

The "Use External Power When Available" option can be set to allow the solenoid box to share any external power provided to the Control box. (i.e. power from any external battery unit).

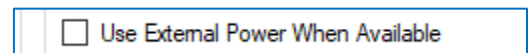

IDT App users:

Equivalent controls are located as follows:
(main) → Configure Device → Control Settings
→ General tab.

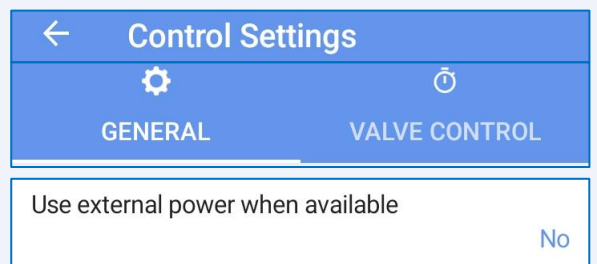

4.20.1 Setup of pressure control using a Time profile

To use a pressure profile that is based on time, tick the “Time control” option.

(When “Flow Control” is disabled, flow does not participate in control decisions, but is still logged).

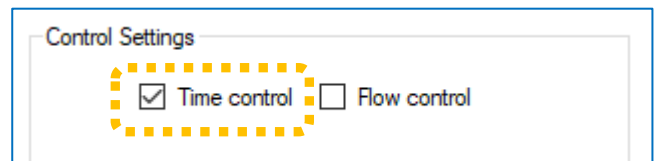

... A “Time Control” settings table will appear following the main Control Settings panel.

Currently (in the illustration), the table is blank; there are no entries visible.

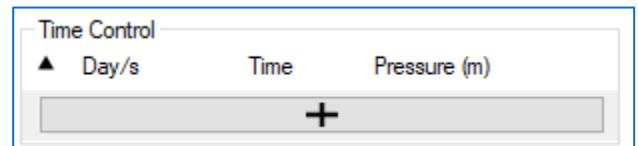

To enter a line into the table, click on the “+” button.

... A new line is added, which can be edited with the required settings.

(The table has a capacity of up to 32 lines).

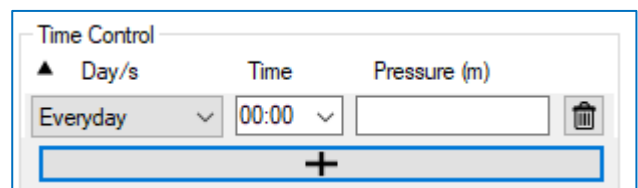

The Time Control pressure profile can be built as a table of days, times, and pressures.

Target pressure is always set using units of “m” (meters).

Each line requires a start time, and a selection of which day / set of days the setting will be relevant to.

The day selections can be mixed.

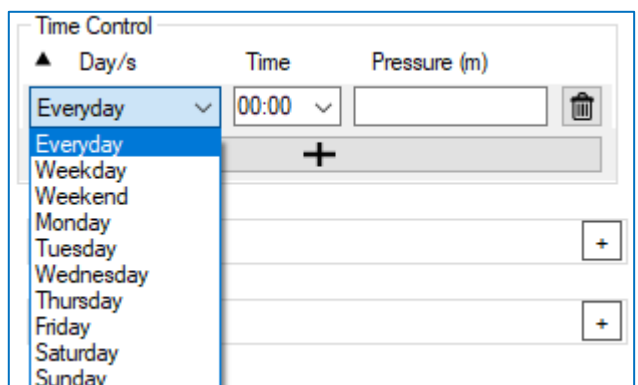

To enter a time, select either the hours or minutes digits and over-write them with your settings.

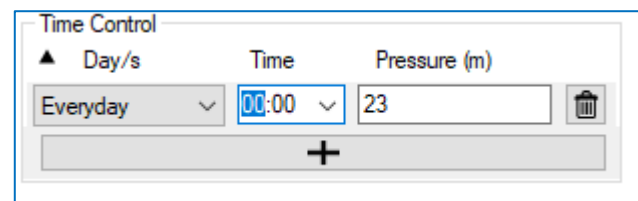

The Time Control profile does not cause a step-change (an immediate switch-over) to the new target pressure whenever reaching an entered time. Rather, there is a linear interpolation between the target pressures stored the profile; the pressure ramps up (or down) between each setting.

e.g. If the table requires 30m at 07:00 and 40m at 08:00, the target pressure at 07:30 will be 35m.

Lines can be added to IDT in any order. After the program has been saved to the device and read back, the profile can be checked; the lines will be re-sequenced according to time of change. Confirm the settings match your expectations.

Time Control		
▲ Day/s	Time	Pressure (m)
Everyday	06:00	40
Everyday	08:00	55
Everyday	21:00	55
Everyday	23:30	40
Weekend	10:00	50
Weekend	21:00	50
+		

Time Control		
▲ Day/s	Time	Pressure (m)
Everyday	06:00	40.00
Everyday	08:00	55.00
Weekend	10:00	50.00
Everyday	21:00	55.00
Weekend	21:00	50.00
Everyday	23:30	40.00
+		

A more specific setting made in the Day selection will over-ride a more general setting.

e.g.

- "Saturday" will over-ride "Weekend" and "Everyday".
- "Weekend" will over-ride "Everyday".

With the settings as shown above:

- Most days have a target pressure of 55m between 8 a.m. and 9 p.m.
- On weekend days the target pressure ramps down from 55m to 50m (between 8 a.m. and 10 a.m.); it stays at 50m until 9 p.m.

IDT App users:

Equivalent controls are located as follows:
 (main) → Configure Device → Control Settings
 → General tab.

Tap on the Control line and select 'Time'.

Tap the 'Time Control' line to reveal the settings, if hidden.

- Tap any field to edit the table.
- Tap 'ADD' to add a new line.
- Lines can be sorted by tapping on the 'Sort' button (ascending time).

Tap the Save button when finished.

←
Control Settings

⚙️
🕒

GENERAL
VALVE CONTROL

Control Time

Time Control ^

Day(s)	Time	Pressure (m)	
Everyday	06:00	40	🗑️
Everyday	08:00	55	🗑️
Tuesday	10:00	50	🗑️

ADD

SORT

Note: When used under the direction of the PressView system, a control table can be larger in size, but is managed via PressView.

4.20.2 Setup of pressure control using a Flow profile

To use a pressure profile that is based on Flow, tick the “Flow control” option.

... A “Flow Control Settings” panel will appear with additional options to set. (These will be discussed later).

The “Flow Control Offset” should usually be set to “not enabled”.

... and a “Flow Control” table will be shown following the main Control Settings panel.

The table shown is blank; there are no entries. To enter a line into the table, click on the “+” button.

... A new line is added, which can be edited with the required settings. (The table has a capacity of up to 32 lines).

The image shows a software interface for configuring pressure control. It is divided into several sections:

- Control Settings:** Contains checkboxes for 'Time control' (unchecked) and 'Flow control' (checked). Below are input fields for 'Deadband' (0.5) and 'Auto Limit' (8.0), a dropdown menu set to 'No Latch', a 'Latch on unreachable duration (mins)' field (20), and a checkbox for 'Use External Power When Available' (unchecked).
- Flow Control Settings:** This section is highlighted with a dashed yellow border. It includes:
 - 'Default Pressure' field: 25.0
 - 'No Flow Timeout (mins)' field: 15
 - 'Sample rate' field: 00:00 10 (with a dropdown arrow)
 - 'Ave' field: 6
 - 'Flow Cal' field: 20
 - Flow Control Offset:** A sub-panel with an 'Enabled' checkbox (unchecked), an 'Offset' field, and 'Start' and 'End' time fields (both set to 00:00).
 - Flow Channel Limits:** A sub-panel with an 'Enabled' checkbox (unchecked), a 'Minimum' field (0.00), and a 'Maximum' field (300.00).
- Flow Control Table:** A table with two columns: 'Flow l/s' and 'Pressure (m)'. The table is currently empty. Below the table is a large '+' button to add a new row.
- Flow Control Table (with entry):** A second view of the table showing one row added. The row has empty input fields for 'Flow l/s' and 'Pressure (m)', and a trash icon on the right. Below this row is another '+' button.

Enter the profile as Flow rate (in liters/second) vs the required PRV outlet pressure.

The Flow Control pressure profile can be built as a table of Flow-rate (in liters per second) and pressures (in meters).

The pressure profile is executed with linear interpolation between the pressures entered into the profile.

e.g. With the settings shown, pressure will be 19m at a 40 l/s flow rate.

Flow Control	
Flow l/s ▲	Pressure (m)
30	13
50	25
100	31
400	44
+	

The lowest entered flow rate defines the pressure when at (or below) that flow rate. Similarly, the highest entered flow rate defines the pressure when at (or above) that flow rate.

IDT App users:

Equivalent controls are located as follows:
 (main) → Configure Device → Control Settings → General tab.

Tap on the Control line and select 'Flow'.

Tap the 'Flow Control Values' line to reveal the settings, if hidden.

- Tap any field to edit the table.
- Tap 'ADD' to add a new line.
- Lines can be sorted by tapping on the 'Sort' button (ascending flow rate).

Tap the Save button when finished.

←
Control Settings

⚙️ GENERAL
🕒 VALVE CONTROL

Control Flow

Flow Control Values ^

Flow l/s	Pressure (m)	
30	13	🗑️
50	25	🗑️
100	31	🗑️

ADD

SORT

(The rarely used 'Flow Control Offset' controls are also located on this screen).

Flow Control Offset ^

Enabled	No
Offset	0.0
Start	00:00
End	00:00

Where flow control is enabled, the system looks at the current flow through the PRV in order to decide upon a target pressure.

The "Sample Rate" determines how often a flow measurement sample is taken for evaluation, *for PRV controller purposes only*.

Some statistical function (average) is applied to smooth out any fluctuation in the measurements which cause rapid and chaotic changes to target pressures. Typically, the system samples every 10 seconds and uses the average from the last 6 measurements to arrive at a target pressure.

"Flow Cal", in the above picture, is a *repeat* of the calibration setting of the Flow channel. (e.g. Units per pulse, for a flow pulse counter interface).

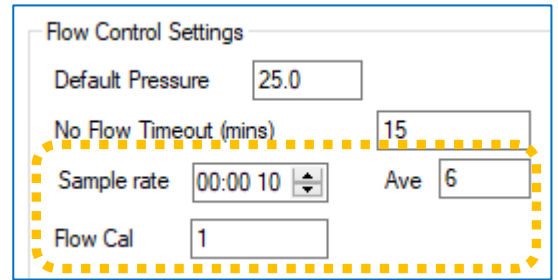

IDT App users:

Equivalent controls are located as follows:
 (main) → Configure Device → Control Settings
 → General tab.

Tap the 'Flow Control' line to reveal the settings, if hidden.

(There is no 'Flow Cal' field available on the IDT app screen).

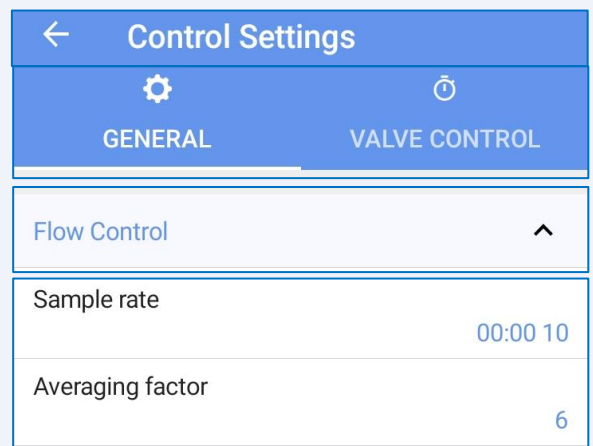

Settings for handling possible flow sensor issues

Since the pressure profile is dependent on Flow, certain settings in the Pegasus define what should happen if a possible fault is detected with the Flow meter:

One condition that can register as a flow-sensor fault is when there are no flow pulses detected. This condition must exist for the time set in the "No Flow Timeout (mins)" field before it is recognized as a fault.

(No specific alarm is generated for this condition, but it is included in the messages delivered to the server during normal call-in).

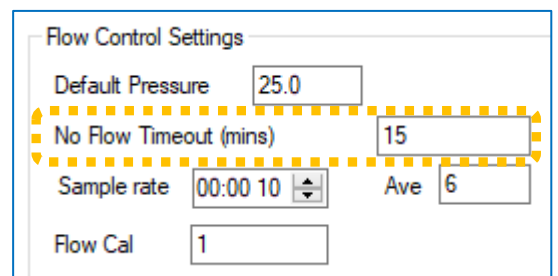

If a fault is detected the target pressure will be the value (in meters) set in the “Default Pressure”.

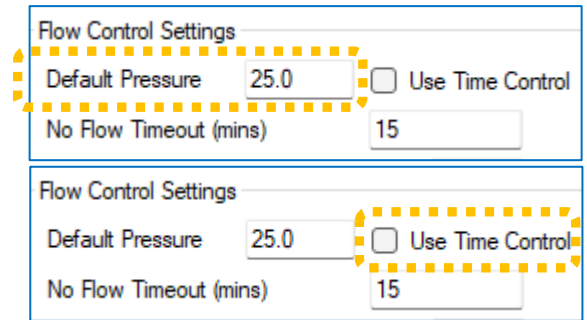

However, when combined Time control and Flow control are enabled (see section 4.20.3), an additional control (called ‘Use Time Control’) becomes visible. If ticked, during a flow sensor fault the default pressure value will be ignored, and the pressure is determined only by the Time Control settings.

Note: The Time control settings must also contain valid settings for correct operation. If disabling Time Control settings, ensure the ‘Use Time Control’ setting is disabled first.

IDT App users:

- For – Default Pressure (for Flow sensor issues)
- No Flow timeout (for fault detection)
- Use Time Control (sometimes visible)

Equivalent controls are located as follows:
(main) → Configure Device → Control Settings
→ General tab.

Tap the ‘Flow Control’ line to reveal the settings, if hidden.
(‘Use Time Control’ is only shown if both Time Control and Flow Control are in use)

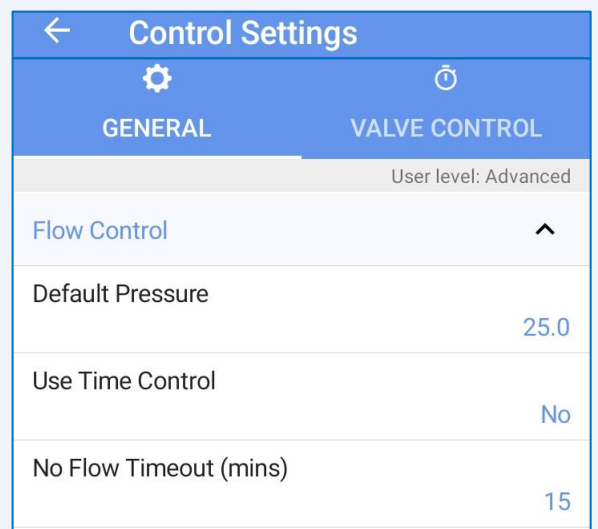

It is also possible for an installer to define their own limits for detecting possible flow problems.

Enable the control and then place upper and lower flow-rate boundaries on the *expected* PRV water flow (in liters / second). When Flow measurements are outside of these limits, Pegasus will use the Default pressure setting as its target pressure.

This could also be used where a flow meter has an upper and lower limit of operation.

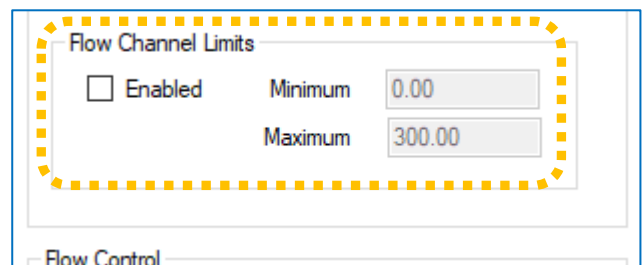

IDT App users:

Equivalent controls are located as follows:
(main) → Configure Device → Control Settings
→ General tab.

Tap the 'Flow Channel Limits' line to reveal the settings, if hidden.

(When 'Enabled' is set to 'Yes', the Minimum and Maximum fields are also shown)

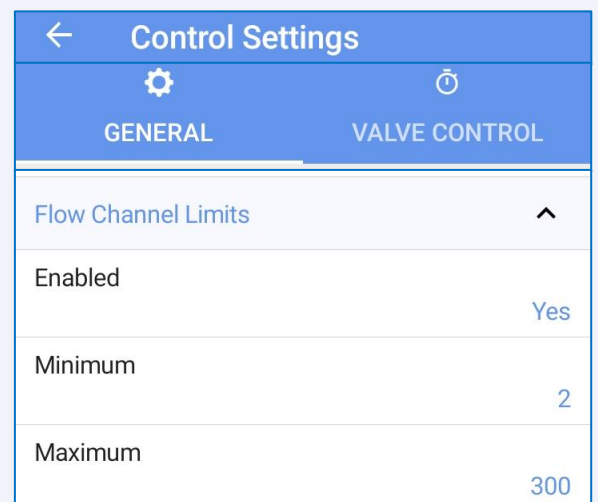

4.20.3 Setup of pressure control using a combined Time and Flow profile

To use a pressure profile that is based on both time and Flow, tick both the "Time control" and "Flow control" options. Then continue to set up both options, as previously described (see sections 4.20.1 and 4.20.2).

... An additional choice becomes visible,
(Which target should be used?)

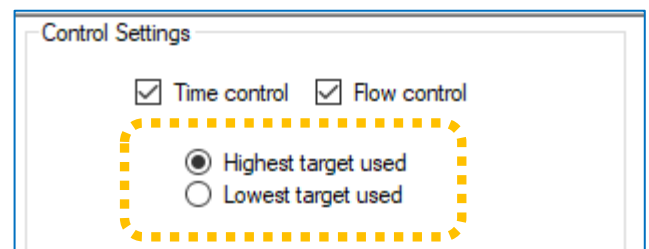

With both options enabled, the controller has to evaluate both tables in order to determine the target pressure.

- It calculates a pair of candidate target pressures (one from each profile table), using the regular process for each of the profiles.
- The chosen option then determines whether the controller works to meet the highest or lowest of the candidate values as its pressure target.

IDT App users:

Equivalent controls are located as follows:
(main) → Configure Device → Control Settings
→ General tab.

Tap on the Control line and select 'Time & Flow'.

Continue to set up both options, as previously described (see sections 4.20.1 and 4.20.2).

An additional line, called 'Target' is available.

Tap the line.

Then select the required option (Highest or lowest of the Flow and Time control tables)

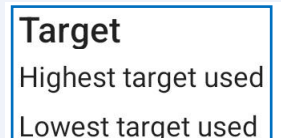
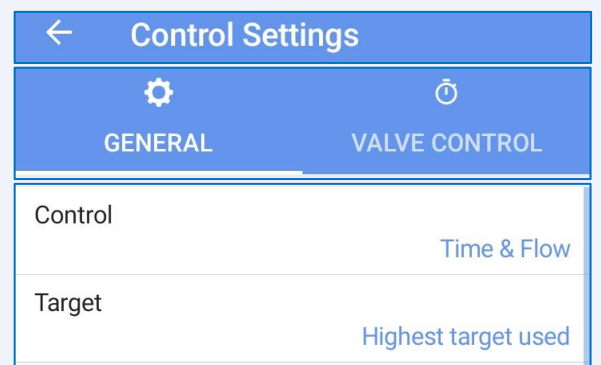

4.21 SETUP FOR ANNUAL TIME ADJUSTMENTS

Some countries have a scheme for adjusting the local time annually to make the most of available sunlight hours and for safety reasons. (e.g. British Summer Time, Daylight saving). Since water usage patterns follow people's behavior, it is possible for Pegasus2 to be programmed to adjust its local clock to match the scheme and thereby temporarily adjust effective times for any time-related pressure profile. Refer to the IDT User Guide for details of how to set (or de-activate) this feature.

IDT App users:

For convenience, the Daylight Savings control settings (as available on IDT Device settings screen, for loggers) are also shown within the PRV Control Settings screen; either can be used.

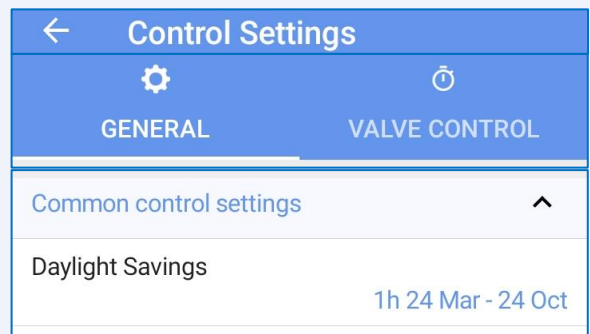

4.22 SAVE PROGRAM & ACTIVATE PRV CONTROL

For Pegasus2 to be able to control the PRV using the current program settings (held by the IDT program), IDT must send the settings to the unit, which must then store it.

Click on the "Setup Device" button, found within the "setup" tab.

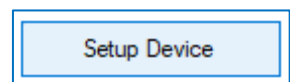

The process will proceed as described in section 2.7.1. However, the installer must now ensure that Pegasus2 is fully activated.

Click on "Yes" when asked if you wish to start controlling now (see section 2.7.2).

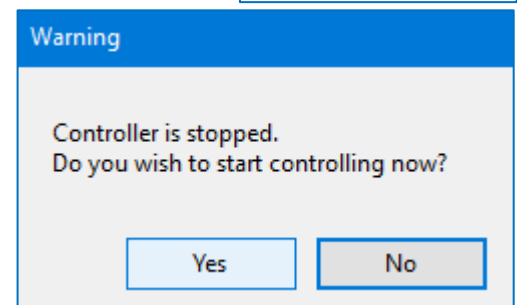

IDT App users:

Whilst setting up PRV control tables, the user will have buttons available to save the settings, when complete.



After tapping on 'Save', settings are saved to the device and the IDT app.

The IDT app checks if the PRV control is running. If it is not, then the user is prompted if it is required to start now. Tap on 'Yes'; the control is re-started (see section 2.7.2).

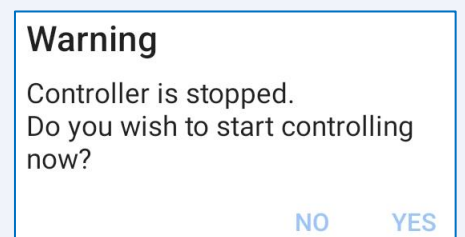

4.23 SETTING LOGGER STARTUP / MEASUREMENT SAMPLE RATES

Pegasus2 should be set to start logging immediately upon being activated.
(See also section 2.7.1).

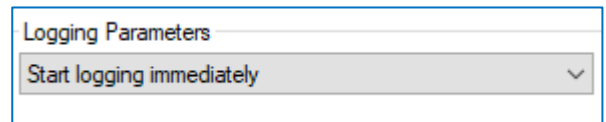

The screenshot shows a menu titled "Logging Parameters" with a dropdown arrow. The selected option is "Start logging immediately".

The built-in logger should be set for measurement interfaces to be logged frequently. Therefore, set to "Log data at specified time interval".

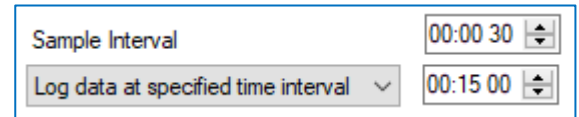

The screenshot shows two settings: "Sample Interval" set to "00:00 30" and "Log data at specified time interval" set to "00:15 00".

The "Sample Interval" is used to produce a set of data for the purpose of applying optional statistical functions (e.g. Average). The "Log data ... interval" is the time interval between producing saved datapoints from the recently sampled set of data.

The settings shown here are typical for Pegasus operation. Refer to the IDT user-guide for steps required to make these settings.

4.24 SETUP OF DATA DELIVERY

Pegasus2 can be setup to call into the HWM DataGate server (over the mobile phone network) at specific times. During a call-in it will send measurement data or receive '(remote) programming commands'.

Setup the Pegasus2 unit with the required call-in schedule.

(Refer to the IDT user-guide for details of each field that requires setup).

Note: If more than two call are required per day, an external battery pack will be required. Without an external battery providing power, Pegasus2 will restrict itself to two calls per day, maximum.

Unsent data will be stored in the unit and will be sent at next call-in.

Set up the Pegasus2 with the following:

(Refer to the IDT user-guide for details and guidance).

- Data destination settings (main) and fall-back / backup options.
(The settings and SMS number required for your company's server will be provided by your **system administrator**).
- Select whether data compression is required.
- When Pegasus2 operates with DataGate / PressView it should always be set to "Call in anyway" (if there is no data to send); This allows remote programming of the device (although if logging has been set correctly, there should always be logged data to send).
- Whether it is appropriate to use SMS messages as a fall-back if the regular communications path is unsuccessful.
- (The setting for whether mains or battery power is in use does not matter for Pegasus2; It automatically detects if an external battery is connected during its operation).
- SIM settings (Access parameters for the Network).

Save the settings when finished.

Note: Do not use any SMS features if your SIM or Cellular Network does not support SMS messages. Refer to the IDT user-guide advice on 2G network switch-off.

4.25 ANTENNA INSTALLATION / CELLULAR COMMUNICATIONS CHECKS

4.25.1 Selection / Preparation / Initial Placement

An antenna should be selected to suit the available space in the chamber, allowing some space for it to be re-positioned (if required). Only use HWM-provided antenna with your logger, to ensure the radio interface meets approvals requirements (safety, etc). The Pegasus2 uses a metal "FME" style antenna connector.

Prior to connecting the antenna, ensure that the connector is dry and clear of dirt and debris; trapped moisture or contaminants can impair the antenna performance. Clean if necessary.

Apply SG M494 silicon grease (or a HWM / FCS approved alternative) to the connector, as required.

Apply a small quantity of WRAS approved silicon grease (type **SG M494**) to the **inside** of the Pegasus connector during installation.

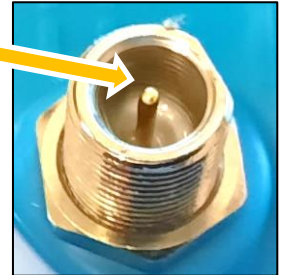

The antenna connector has an O-ring included for protection against water and moisture ingress; it acts as a seal. Check that the O-ring is present and undamaged.

Ensure that the connector and O-ring are dry and clear of dirt and debris. Clean carefully if necessary.

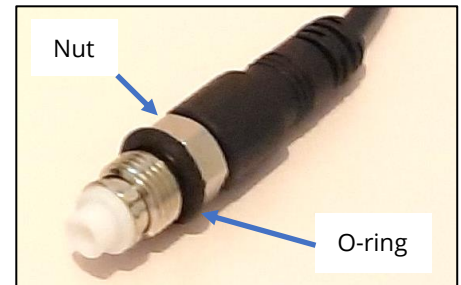

Insert the antenna connector into the logger connection and ensure it is fully home. Tighten the connector correctly; the nut on the antenna should be finger tight, plus 1/4 turn.

No sharp bends should exist at the cable ends, or in the routing of the antenna cable.

To avoid risk of crush damage to the antenna cable, check that no equipment is placed onto it. Similarly, cable ties fixing the cable in place should not be too tight.

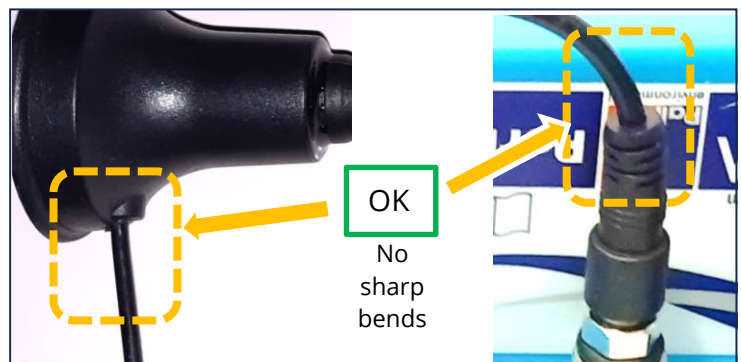

The antenna should not be bent to fit the installation; if it is too big for the chamber, use a smaller type of HWM approved antenna.

When positioning the antenna, ensure that the radiating end of the antenna does not touch or go close to a metal surface.

The radiating element of the antenna should ideally be positioned in free air (free from obstructions).

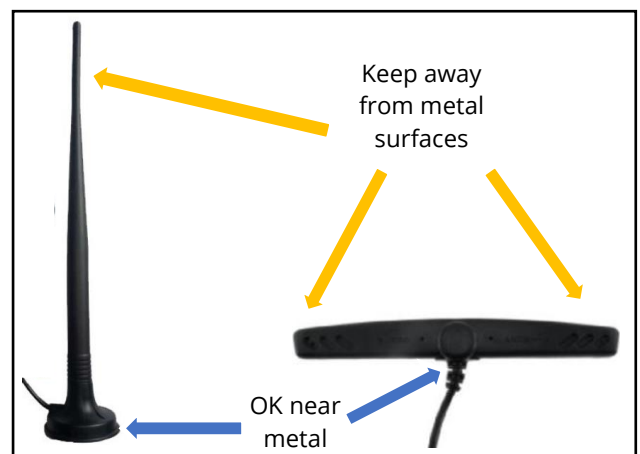

Try to avoid placing the antenna in a location where it can be flooded. If this is unavoidable, then place it where the risk is at its minimum.

For equipment that is installed in a chamber below ground level, the antenna should be placed above ground level if possible. Where this is not possible, position it near to the top of the chamber.

Some general advice is given below:

Monopole Antenna

For most installations, a monopole antenna will give acceptable performance.

Installation Considerations:

- Always comply with any installation restrictions as per warnings in the documentation supplied.
- The antenna has a magnetic base to be used for mounting. For optimum performance, the antenna requires a "ground plane" (metal surface) at its base.
- When installing the antenna in large underground chambers it should be positioned close to the surface.
- Ensure that any chamber lid will not interfere with the antenna or cables when being opened/closed.
- This antenna is vertically polarized, it should always be installed in the vertical orientation.
- Never bend the radiating element of the antenna.
- The antenna can also be attached to an installation bracket mounted to an existing marker post.
- Where an antenna is held in place by magnets, ensure the weight of any cables does not excessively load the magnet so as to detach it from the installed location.
- Do not allow any equipment to rest on the antenna connector as crush damage to the connector or antenna cable can result.



For other antenna options and additional installation guidelines, refer to the documents available on the support webpage: <https://www.hwmglobal.com/antennas-support/>

4.25.2 Antenna / Communication checks

IDT should be used to check that the logger can connect to the cellular network and that the antenna is in the optimal position for the site.

- Choose a suitable antenna for the installation and decide on its initial position.
- Determine the network technology being used (i.e. 2G, 3G, 4G, etc) and then use the appropriate signal quality limits (refer to the IDT user-guide).
(Details can be found in MODEM settings, which is a specialist subject. However, it is not necessary to inspect or modify these in most situations. During 'signal tests' IDT will provide additional information that can determine which guidelines tables to use for judgment of signal suitability.
(CSQ value for 2G and 3G networks. RSRP and RSRQ values for 4G networks).

- Perform Network Signal tests (with the chamber lid closed) to confirm the logger connects to the mobile network and find the best location of the antenna. Re-position if required.
- Perform test calls to confirm the logger can communicate with the DataGate server via the internet and (if available and required) SMS.

(Details of use of IDT for making these tests are provided in the IDT user-guides).

Trouble-shoot a test-call failure if required, using the advice in the IDT app user-guide. Further information is given in the HWM Antenna Installation Guide (MAN-072-0001).

4.26 VERIFICATION OF THE

CONFIGURATION. Prior to leaving site:

- It is recommended to check the settings in Pegasus2 to verify the configuration has been correctly saved.
- Check the status is set to "Recording".
- Check the PRV controller 'Start control' button is green.

4.27 PROTECTION FROM FROST

Where required, the colored tubing can be protected from frost with foam insulating pipe covers. These can be supplied upon request at additional cost or sourced locally from a hardware store.

To protect the pressure transducers from frost, Pegasus2 has the option of being supplied with external transducers, rather than internal transducers. This removes the possibility of the column of water within the pressure hoses connecting to the internal transducers of the controller from freezing and potentially becoming damaged, if left unprotected in harsh conditions.

5 INSTALLATION (NON-STANDARD / LATCH ON LOW UNREACHABLE)

WARNING: This equipment should be installed, adjusted, and serviced by qualified water industry maintenance personnel familiar with the construction and operation of the equipment and the hazards involved. Failure to observe this precaution could result in damage to the water network.

The installer will be required to become familiar with the use of IDT as it is used at various parts of the installation process. (e.g. It is required in order to bleed air out of the system, test Pegasus2 operation, and program a pressure profile).

This type of installation is intended for the following use / application:

- Typically, the latch circuit becomes activated when the target pressure is set to be 0m during that part of the day, in order to shut down the water supply to the area. At other times, the target pressure is increased to resume water supply. Pegasus2 responds by de-activating the latch valve and resumes pressure control via use of the pilot and the mechanical actuator.

Installation and setup should follow a similar process as that described throughout section 4 (and subsections), but with some differences:

5.1 MODIFICATION OF PLUMBING AND OPERATION

Non-Standard operation (and modifications to plumbing) are described in 2.12.5.2.

The Inlet and Vent ports have their use and plumbing swapped over. This must be taken into consideration when following any illustration examples of 'standard' installations.

To set Pegasus2 to use this non-standard plumbing (and corresponding non-standard internal operation of the unit) ensure the 'System is connected to allow valve to be fully closed' setting is set to enabled (ticked or Yes), as shown below:

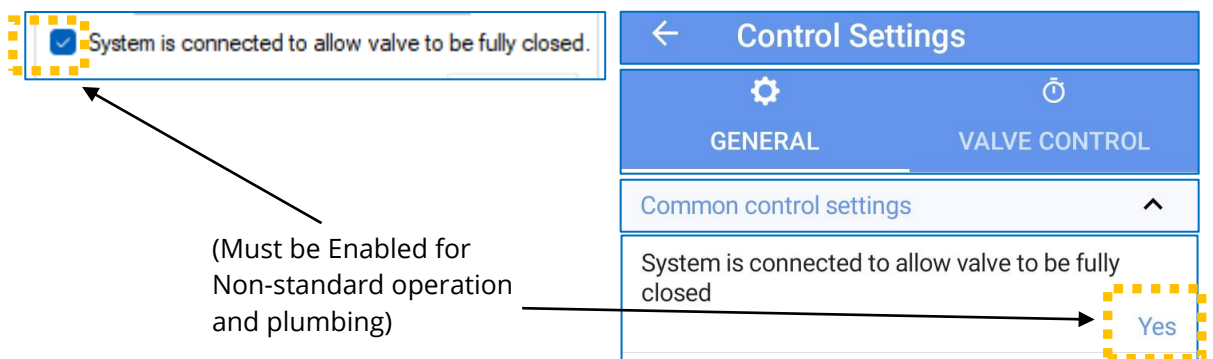

The above IDT setting changes the operation of the two ports (labeled inlet and Vent).

Be sure to swap the connections to the plumbing also.

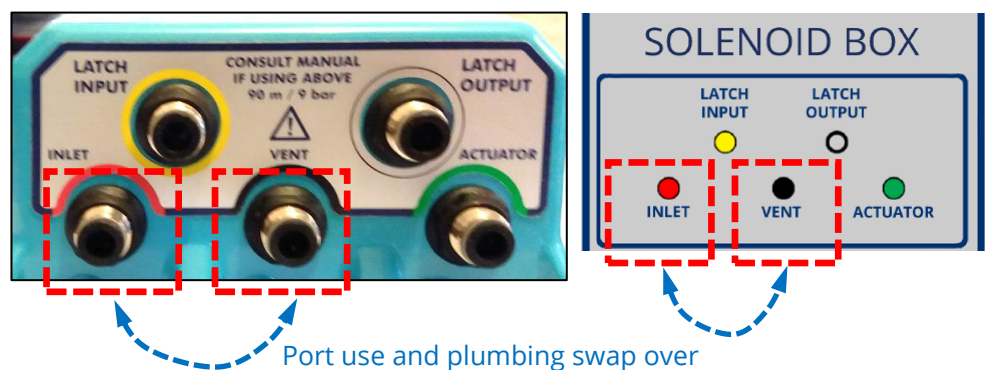

5.2 MODIFICATION OF LATCH SETTINGS AND OUTCOMES

Refer to section 4.20, which discusses latch behavior. The 'Latch on Low unreachable setting' can be used. Refer also to section 2.12.5.2. for an explanation of revised Pegasus2 / PRV operation. Note the warnings against other settings.

When plumbed into the upper chamber of the PRV, activation of the Latch will cause the PRV to switch between being regulated under control of the pilot valve or bypass of the pilot valve.

Facilities are available to manually test the latch (solenoid valve) option using buttons within the IDT tool. The latch can be opened or closed by the installer. However, a modification to section 4.18 (Latch option - Testing) applies:

Caution: The installer should be mindful of the subsequent affect to the water outlet pressure **before manually operating the latch solenoid to by-pass the pilot valve.**

- ** With non-standard plumbing, the **Outlet will decrease in water pressure,** causing the **water supply to be cut off** when by-passing the pilot valve.
- ** Ensure the outlet water pressure being cut off can be tolerated by users of the water network prior to manually operating the Latch solenoid valve. (e.g. Test at a time when water is intended to be cut off).

(When correctly set up and running under automatic control, Pegasus2 will bypass the pilot valve only when the outlet water pressure is intended to be low (and a further reduction is desired).

5.3 MODIFICATION OF CONTROL METHOD

Usual setup is to use Time Control only; This can be set to follow the desired outlet pressure including taking the pressure to 0m at the times when the outlet water supply is intended to be cut off.

6 INSTALLATIONS WITH PARALLEL PRVs

Pegasus2 can be used in certain situations where there are two Pressure Reducing Valves installed in parallel. At any time, one PRV takes the majority of the flow, but the PRV being used is regularly swapped over. Alternating use of the units keeps both PRVs exercised.

An example application is illustrated below. The Pegasus2 is operating in a standard configuration (without use of the 'latch' solenoid). A Hydroswitch unit (available from HWM) controls a latching solenoid (external to Pegasus2). The Hydroswitch itself is controlled by the Pegasus2 unit.

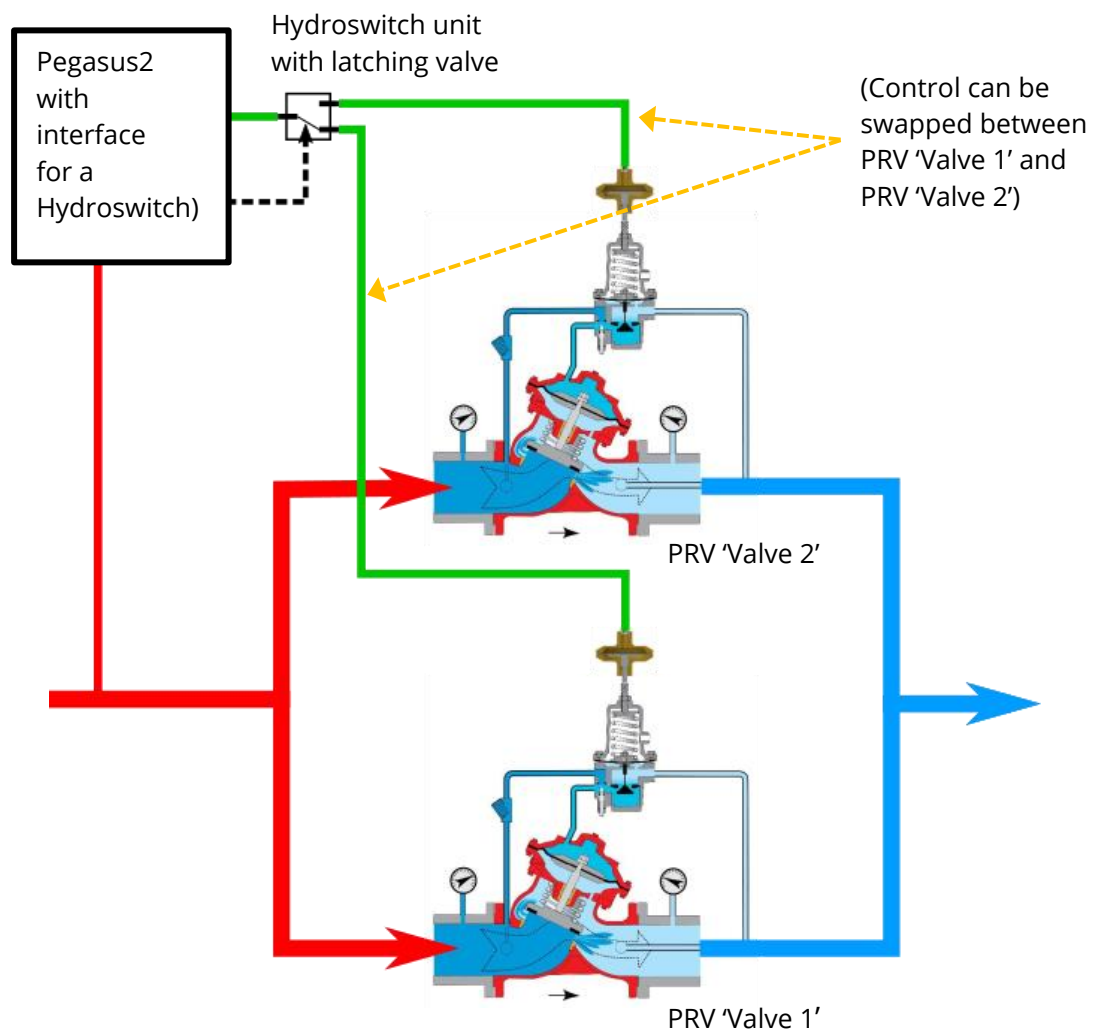

Note: For this type of installation, the Hydroswitch must be connected to an interface within the Pegasus2 Control box.

To successfully use Pegasus2 to change over from the PRV currently in use to (use and control) the alternative PRV, the changeover should be timed to occur when the water flow is expected to be minimal, and the outgoing pressure is also low. (Typically, this will be during the night). After changeover, as demand increases, the old PRV makes minimal contribution to the combined flow. The Pegasus controls the new PRV, which becomes the dominant source of water flow.

The Hydroswitch changeover is controlled by the 'Secondary Time Control' settings, located with the Setup tab.

Enter the required changeover time.

Tick the 'Enable Secondary Control' box; a table will be shown (PRV switchover table). Edit the table to the required changeover pattern.

During operation, the Pegasus2 will cycle through the table values until finished, and then re-start the pattern.

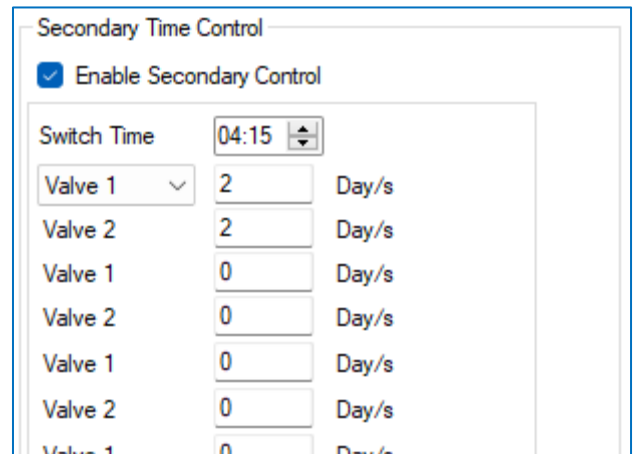

During installation, the mechanical actuator of each PRV should be set whilst the alternative one is in the low-flow condition.

The IDT tool provides controls to assist with switching between the PRVs during installation and test.

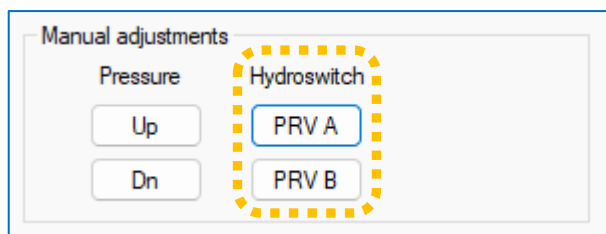

In the PRV Installation tab, there are buttons to set the open path of the Hydroswitch. (There is a delay of 10 seconds when switching):

- Click PRV A button to open the path between Common and Port A. Port B becomes sealed.
- Click PRV B button to open the path between Common and Port B. Port A becomes sealed.

With control running, the change lasts approximately 60 seconds.

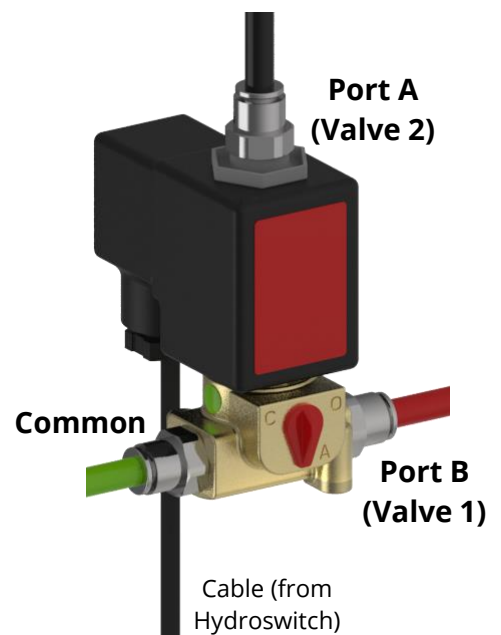

A change of longer duration can also be made using the 'Secondary Override' panel.

Add the desired duration, select the required open path, then click the Override button. (The PRV 'Control' process must be running when using this control).

The Hydroswitch valve will change to the desired path for the specified time. Then it will return to its previous state (if different).

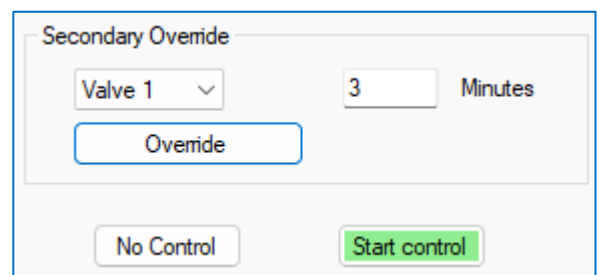

IDT App users:

- For – Enable Secondary Control,
 - Switch Time,
 - (PRV switchover table)

Equivalent controls are located as follows:
(main) → Configure Device → Control Settings
→ Valve Control tab.

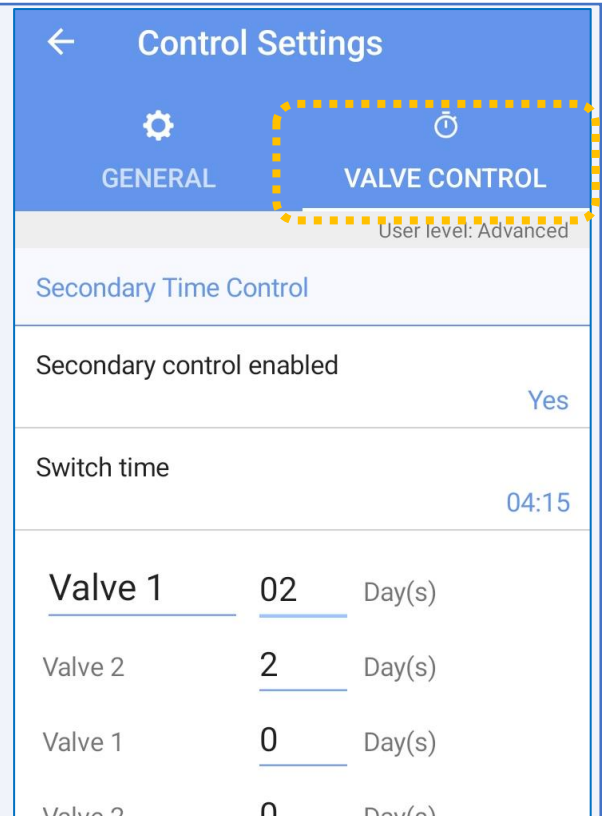

- For – Manual adjustment of Hydroswitch (PRV A & PRV B buttons)
 - Secondary Override

Equivalent controls are located as follows:
(main) → Test Device → PRV Installation.

Tap the 'Manual adjustments' line to reveal the Hydroswitch buttons, if hidden.

Tap the 'Secondary override' line to reveal the settings and Override button, if hidden.

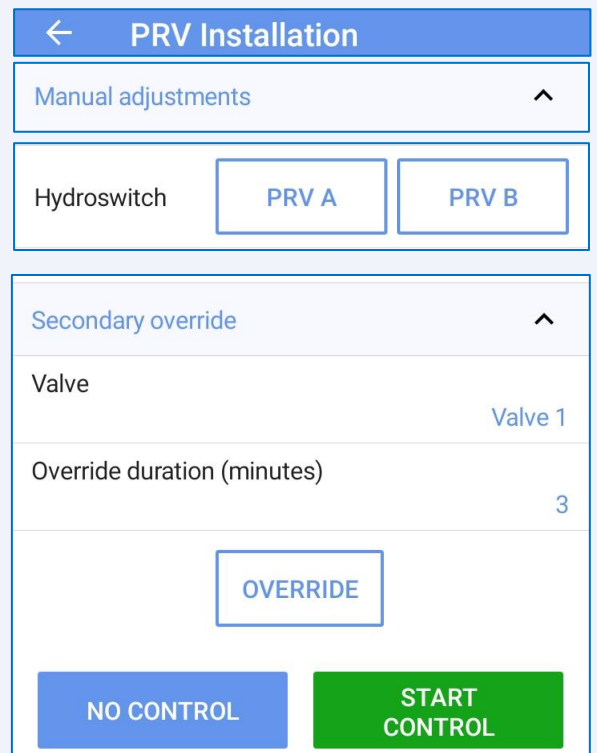

7 GRAPHING / DATA DOWNLOAD AND PREVIEW

Measurements are saved by the Logger functionality built-into Pegasus. Measurements are normally incrementally uploaded to the DataGate server so that they can be:

- Viewed remotely.
- Optionally, be used by the PressView system to fine-tune the performance of the Pegasus profile tables.

Data can also be downloaded from the unit into IDT for previewing locally.

For the steps required to download a range of data into IDT (for preview as a graph) refer to the IDT user-guide.

8 CONNECTION INFORMATION

8.1.1 FLOW Meter connection / cable RAG 93

Flow meter pulse unit cable (RAG R93).

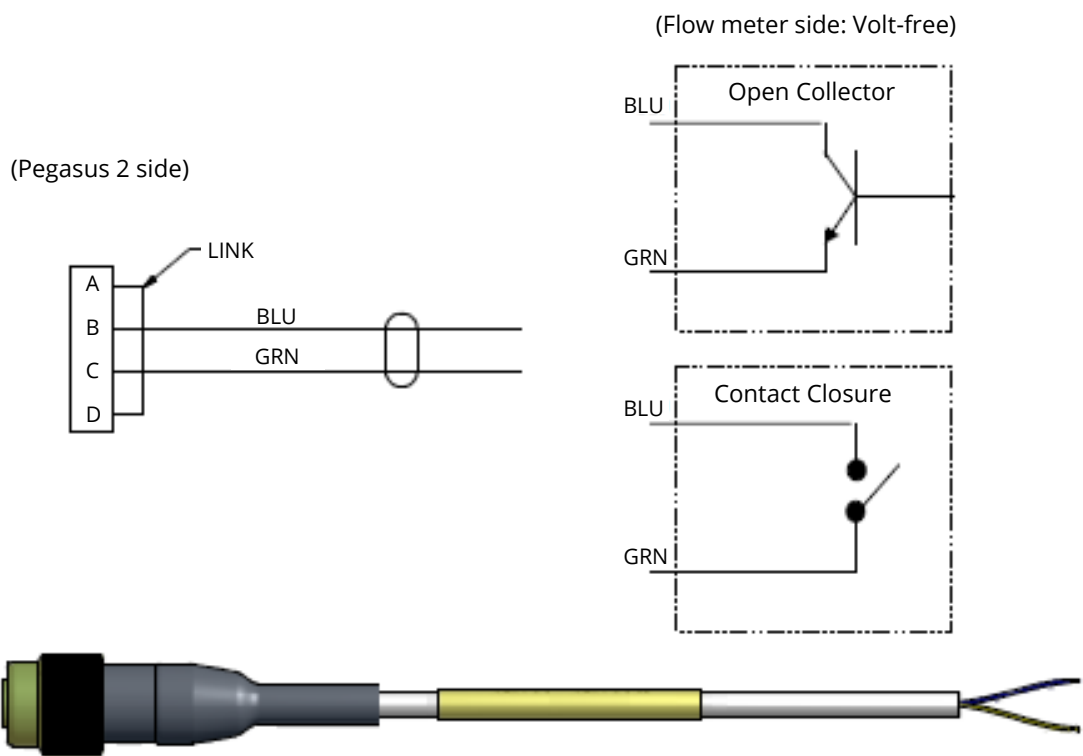

Connect the cable to the flow meter's volt-free pulse interface:

- Use the green wire as ground.
- Use the blue cable as signal.

Direct flow meter connections available on request.

9 MAINTENANCE, SERVICE AND REPAIR

Unauthorized servicing will void the warranty and any potential liability for "HWM-Water Ltd".

Electronic controller

The built-in logger will continue to record data in its memory until the battery completely fails. The data logger cannot be downloaded after this condition occurs.

Batteries

- Only use batteries and parts recommended and provided by HWM.
- Batteries are replaceable by a HWM approved service center or relevantly trained technician.
- Batteries can be returned to HWM for disposal. To arrange the return, complete the on-line RMA form: <https://www.hwmglobal.com/hwm-rma/>
Refer to the Safety Warnings and Approvals Information for guidelines of the packing requirements.

Antenna

- Only use antenna recommended and provided by HWM.
- For details of antenna options and part-numbers to order, refer to the following link: <https://www.hwmglobal.com/antennas-support/>

SIM-card.

- SIM-cards are replaceable by a HWM approved service center or relevantly trained technician.
- Only use consumable parts recommended and provided by HWM.

Hydraulic Components

- The hydraulic system consists of quick couplings, hoses and actuator that may require maintenance during the normal life of these products. To obtain these parts contact HWM-Water Ltd via your sales representative.

9.1.1 Return of product for Investigation, Service. Or Repair:

When returning product for investigation or repair, be sure to follow the instructions of your distributor to document why the product is being returned.

If returning to HWM, this can be done by completing the on-line RMA form:

<https://www.hwmglobal.com/hwm-rma/>

Prior to shipping, put the equipment into Shipping mode (see section 9.1.2). Refer to the Safety Warnings and Approvals Information for guidelines of the packing requirements.

9.1.2 Putting the equipment into Shipping Mode

Before long term storage, moving an installed unit, or shipping for repair, the Pegasus2 unit should have the PRV control stopped and then it should be put into “Shipping mode”. Be sure to upload any unsent data before this operation.

To stop the PRV control:

Read the current configuration of the Pegasus using IDT.

From within the “PRV Installation” tab, click on the “No Control” button.

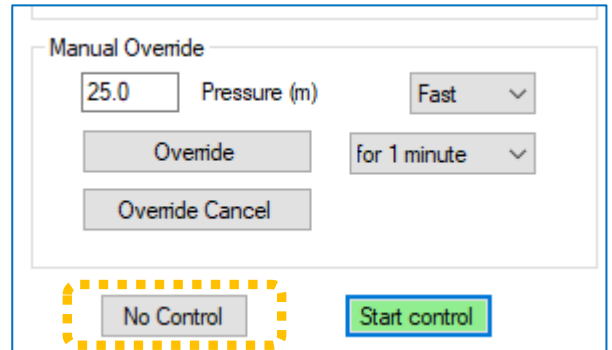

Wait until the button has turned pink; PRV control process is now inactive.



IDT App users:

Equivalent controls are located as follows:
(main) → Test Device → PRV Installation

Tap on the ‘No Control’ button.

After a few seconds the button will change to red, indicating the PRV control process is now inactive.

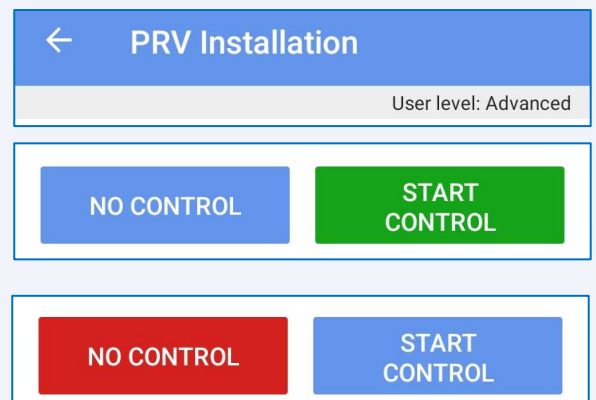

To put the Pegasus 2 into shipping mode:

From within the “Setup” tab, scroll to the end of the settings panels and click on the “Stop Device” button.

Click “Yes” when warned that calls will be stopped.

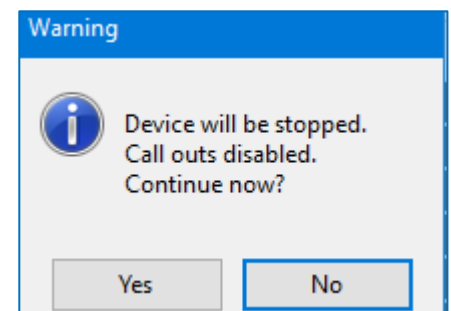

The unit will be re-programmed.

IDT will warn that the logger device has been stopped.

Click "OK" and confirm that the status of "(Stopped)" is shown at the top of the IDT Logger panel.

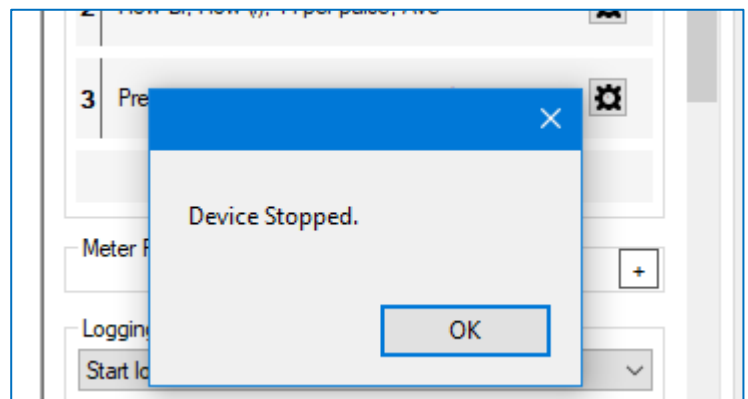
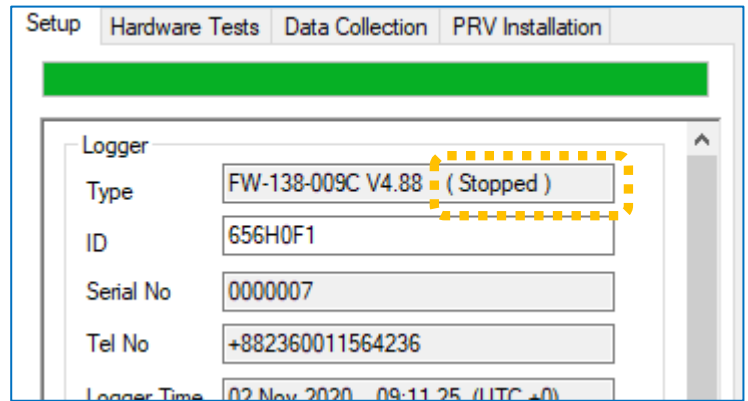

Note: The unit may now be re-packed for shipping or long-term storage.

IDT App users:

Equivalent controls are located as follows:
(main) → Configure Device → Device Information

Tap on the 'Stop Device' line.
After several warning / confirmation messages, IDT will eventually inform that the device has been stopped; this refers to the logging functions.

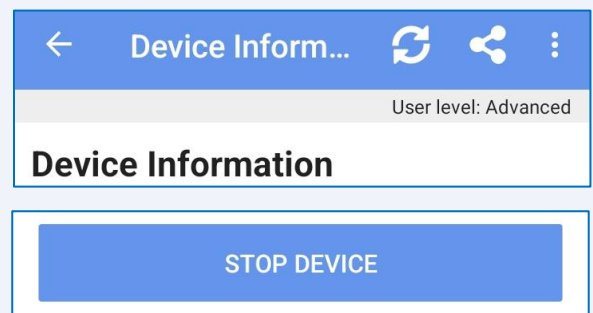

9.2 WATER INGRESS

If Pegasus Solenoid box is subjected to water pressure exceeding 10 bar it is possible that internal damage may occur, and that water may enter the unit. The equipment may then fill with pressurized water. The unit contains a safety feature if this occurs. A pressure relief valve (see opposite) is fitted which may be activated by this fault condition.

The unit will also attempt to send an alarm to the server if it detects a high internal pressure.

If there is any evidence of water ingress into the unit, do not operate it, but return the unit for service and repair.





Fluid Conservation Systems
1960 Old Gatesburg Road
Suite 150
State College PA, 16803
(800) 531-5465
www.fluidconservation.com

©HWM-Water Limited. This document is the property of HWM-Water Ltd. and must not be copied or disclosed to a third party without the permission of the company. All images, text and designs are protected by international and UK copywrite law and remain the property of HWM-Water. It is against the law to copy or use any of the content from the HWM website or literature without the written consent of HWM-Water. HWM-Water Ltd reserve the right to vary the specification.

MAN-163-0002-C April 2024.