



# FCS™

The Sound Choice  
for Leak Detection.™

## User Manual: SonicSens 3

(Part 1 / 2)

## Installation and Setup.



SonicSens 3



SonicSens 3 + Install options

**Warning:**



This manual contains important safety and operating information. Please read, understand, and follow the instructions in the manual and also any safety / approvals or Intrinsic Safety (ATEX or IECEx or UKEx) Safety Supplement documents shipped with the device.

## TABLE OF CONTENTS

1	Introduction, Safety and Support of Product.....	5
1.1	Documentation and Support of Product .....	5
1.2	Safety Considerations.....	6
2	Overview: .....	7
2.1	Device - Overview.....	7
2.2	SonicSens 3 Installation accessories .....	8
3	Choosing the correct sensor range and position .....	9
4	Installation of IDT / Communicating with the logger .....	11
5	IDT(PC) SonicSens 3 connection and pre-installation test .....	12
5.1	Connect the SonicSens 3 to the logger .....	12
5.2	Confirm SonicSens 3 is recognised .....	13
5.3	Select a suitable SonicSens 3 profile .....	13
5.4	Trial the installation position .....	15
5.5	Automatic Range Selection feature .....	16
5.6	Temperature Override feature .....	16
6	IDT(PC) Installation of SonicSens 3 and Profile Adjustment .....	18
6.1	Installation .....	18
6.2	Profile adjustment .....	22
6.3	Echo Check / Threshold adjustments.....	23
7	IDT(PC) Setup of Basic Measurements .....	25
7.1	Measurement of Distance.....	25
7.2	Measurement of Depth .....	25
8	IDT(PC) Logging Basic Measurements – Setup of Data channels.....	26
8.1	Distance or Depth .....	26
8.2	Measurement Quality (of distance) monitoring.....	28
9	IDT(PC) Setup of Additional Measurements.....	29
9.1	Flow of water from a WEIR.....	29
9.2	Flow of water through an open channel.....	31
10	IDT(PC) Logging Additional Measurements.....	33
11	IDT(PC) Setup of Alarms .....	35
12	IDT(PC) Additional Options .....	35

12.1	Volume-based pulse output.....	35
12.2	SonicSens 3 tests .....	36
13	IDT(app) SonicSens 3 connection and pre-installation test .....	37
13.1	Connect the SonicSens 3 to the logger .....	37
13.2	Confirm the SonicSens 3 is recognised.....	37
14	IDT(app) Setup of Logger to read data from SonicSens3.....	39
14.1	Distance .....	39
14.2	Measurement Quality (of distance) monitoring.....	42
14.3	Ambient Temperature .....	44
15	IDT(app) Installation of SonicSens 3.....	44
16	IDT(app) Setup of Basic Measurements from SonicSens3.....	45
16.1	Measurement of Distance.....	46
16.2	Measurement of Depth .....	48
16.3	SonicSens 3 profile setup (Range and Threshold adjustment) .....	49
16.3.1	Range adjustment .....	49
16.3.2	Echo Check / Threshold adjustments .....	50
17	IDT(app) Setup of Additional Measurements.....	54
17.1	Flow of water from a WEIR.....	54
17.2	Flow of water through an open channel.....	58
18	IDT(app) Setup of Alarms .....	60
19	User-serviceable parts .....	60
20	Troubleshooting .....	60

---

# 1 INTRODUCTION, SAFETY AND SUPPORT OF PRODUCT

---

## 1.1 DOCUMENTATION AND SUPPORT OF PRODUCT

Thank you for choosing a HWM device. We trust it will provide you with many years of service.

“SonicSens 3” is a sensor that measures distance, typically being installed to measure the distance to the surface of a body of water. It can connect to various HWM logger devices, which provide it with power and read measurement results from it.

This user-guide covers the following models:

<u>Model Number(s)</u>	<u>Description</u>
SONIC3 / 6 / * / IS	SonicSens 3 (Intrinsically Safe). 6m max range.
SONIC3 / 10 / * / IS	SonicSens 3 (Intrinsically Safe). 10m max range.

This user-guide must be read in conjunction with:

MANEX-153-0001	SonicSens3 - Safety Supplement,
MAN-153-0003	Safety Warnings and Approvals Information

In addition, this user-guide should be read in conjunction with one of the following user-guides (depending on the programming tool used by your logger):

MAN-2000-0001	IDT (mobile app version) user-guide or
MAN-130-0017	IDT (PC version) user-guide

This user-guide covers only the SonicSens3 sensor. Refer also to the user-guide of your HWM logger for additional information.

HWM provides support of the product by means of webpages:

<https://www.hwmglobal.com/sonicsens-3-support/>

Should you have any questions that are not covered by a manual, or Frequently Asked Questions (FAQs) provided online, please contact the HWM Technical Support team on +44 (0) 1633 489479, or email [cservice@hwm-water.com](mailto:cservice@hwm-water.com)

Acknowledgements:



The Bluetooth® word mark and logos are registered trademarks owned by Bluetooth SIG, Inc. and any use of such marks by HWM-water Ltd is under license. Other trademarks and trade names are those of their respective owners.

## 1.2 SAFETY CONSIDERATIONS

The SonicSens3 family of sensors include Intrinsically Safe models.

**Intrinsic Safety** is a method of ensuring the unit will operate safely in certain hazardous environments (those having a potentially explosive atmosphere). Equipment passing safety evaluation of Intrinsic Safety (**ATEX or IECEx or UKEx**) will include markings on the equipment regarding the conditions under which it can be used.

Before continuing, carefully read and follow the information in the “**Safety Warnings and Approvals Information**” document supplied with the product.

This provides general safety information.

The installer or maintainer must also refer to any other **safety supplement** documents, supplied with the intrinsically safe versions of the product. This will provide additional Intrinsic Safety related safety information including port parameters.

Retain all documents for future reference.

Before using this product, make a risk assessment of the installation site and expected work activity. Installations in a hazardous environment (e.g., ATEX or IECEx or UKEx) should be carried out by appropriate technicians with suitable training for that environment.

Ensure any tools necessary for installation are suitable for use within the hazardous environment. Ensure suitable protective clothing is worn and working practises are followed during installation and any maintenance. Check with the site owner or supervisor for any additional safety requirements before commencing work.

For installations within potentially explosive atmospheres, only use an Intrinsically Safe model of SonicSens 3, which should be used in conjunction with an Intrinsically Safe model of HWM logger. Confirm that the SonicSens 3 and the logger used both have suitable safety markings (ATEX or IECEx or UKEx). Ensure any communications cable used to attach a logger to a PC also has suitable safety markings (ATEX or IECEx or UKEx).

Ensure any communications device being used to assist in the install or setup of the logger (e.g., P.C. or mobile phone) is also suitable for use in any hazardous environment in which you are working.

SonicSens 3 can also be used within installations that do not require Intrinsically Safe equipment.

## 2 OVERVIEW:

---

### 2.1 DEVICE - OVERVIEW

SonicSens 3 is a sensor that measures distance. It is typically installed to measure the distance to the surface of a body of water. It can connect to various HWM logger devices, which provide it with power and read measurements from it.

There are different models available, which are mechanically similar in construction but slightly different in size. The models have different measurement ranges.

SONIC3 / 6 / \* / IS models have a range of up to 6 meters.

SONIC3 / 10 / \* / IS models have a range of up to 10 meters.

(Note: Refer to the HWM datasheet for SonicSens 3 for additional specifications).

The sensor has a 6-pin connector on top of the unit, to which a cable with water-tight connectors can be attached (and a similar connector will exist on the logger). The cable can fit either way around. All connectors should be kept free of moisture.



Ensure your logger has a SonicSens 3 interface installed before attempting installation. This can be determined by the port label on the logger, or from the part-number of the logger. *Refer to your logger's manual for guidance.* Also check the connector on the logger side has the correct number of pins.

The SonicSens 3 is an intelligent device, containing microcontrollers. It also contains an ultrasound transducer. It operates by emitting focussed high-frequency sound pulses, which travel to the surface of the water and are reflected back to the sensor. The sensor recognises the pulse pattern and determines the time delay for the echo to arrive. The time delay is converted into a distance measurement.

Each SonicSens 3 is calibrated within the factory before shipment. The calibration settings, model-number and serial number are stored within the SonicSens 3. All other (use-related) configuration data and settings are stored within the logger. This makes units of the same model-number interchangeable, allowing failed units to be replaced without any further setup.

SonicSens 3 is powered down by the logger when not required, to save power. Each time it is required to make a measurement, the configuration details are sent to the SonicSens 3 and a measurement is requested. The sensor makes the measurement and then gives the result to the logger device. The logger temporarily stores the data,

further process it if required, and eventually uploads data it to a system which stores the measurement data of the site (e.g., DataGate); Refer to the logger manual for more details.

The SonicSens 3 must be mounted securely above the body of water. Accessories for mounting the unit are available to suit most installation options. After mounting the SonicSens 3, some checks and distance measurements are usually required to be made from the installation site.

Although the unit primarily measures the distance to the surface of the body of water, the logger can be used (with site measurements) to derive a more comprehensive list of measurements.

Various cable lengths are available to connect the SonicSens3 to the logger, giving the option to mount the logger close to the SonicSens3 or further away. Due to the variation in cable length allowed, it may be necessary to adjust the "cable length" setting during installation (see section 16). (Note: This may also depend on the logger used).

The SonicSens 3 requires a PC software tool called "IDT" (Installation Diagnostic Tool), provided by HWM, in order to set up its functionality. There are 2 versions of the IDT tool, a PC version (requiring a communications / programming cable), and a mobile-app version (requiring a mobile phone with Bluetooth connectivity); Refer to your logger user-guide regarding which one to use.

## **2.2 SONICSENS 3 INSTALLATION ACCESSORIES**

The following accessories are available:

- Mounting bracket (fixed).
- Mounting bracket (hinged – Fold left).
- Mounting bracket (hinged – Fold right).
- Clamps (female, male).
- Sensor bracket (2 sizes) with bubble level.
- Extension posts (various lengths).
- Submergence shield.
- Sound Deflector plate (Stainless steel). (Check with HWM for availability and use).

### 3 CHOOSING THE CORRECT SENSOR RANGE AND POSITION

The SonicSens 3 emits a focused ultrasonic pulse, which travels in a cone-shaped beam from the bottom of the unit. The beam is approximately 10 degrees cone (refer to the Datasheet). The beam should be targeted at the surface of the water (more precisely, at the base of the water container).

The path of the beam should be clear of objects, including the side walls of the chamber, since it can affect the echo that the sensor is trying to detect. It is important to check below the water surface for any features that can cause problems, as otherwise the beam may be deflected in another direction only when the water depth is low.

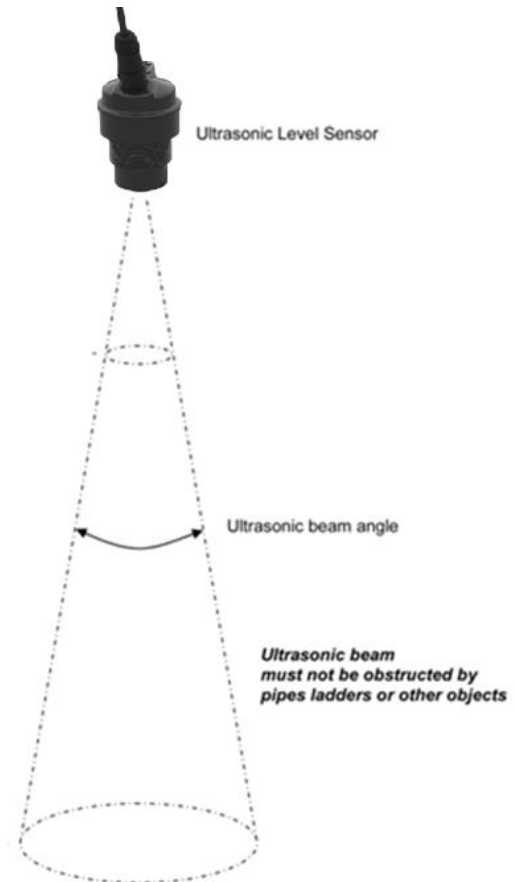

Choose a sensor with a the most suitable distance range for the maximum and minimum water levels.

When the SonicSens 3 operates outside of its specified range, results can be inaccurate, or the unit will be unable to produce a measurement result. Regions outside of the working distance of the sensor are also called the sensor's "dead bands".

Refer to the relevant datasheet of the model of SonicSens 3 you are using for the working range.

(See also section 6.2 or 16.3).

The water minimum level (base of the water container) and maximum level must be within the working range of the SonicSens 3.

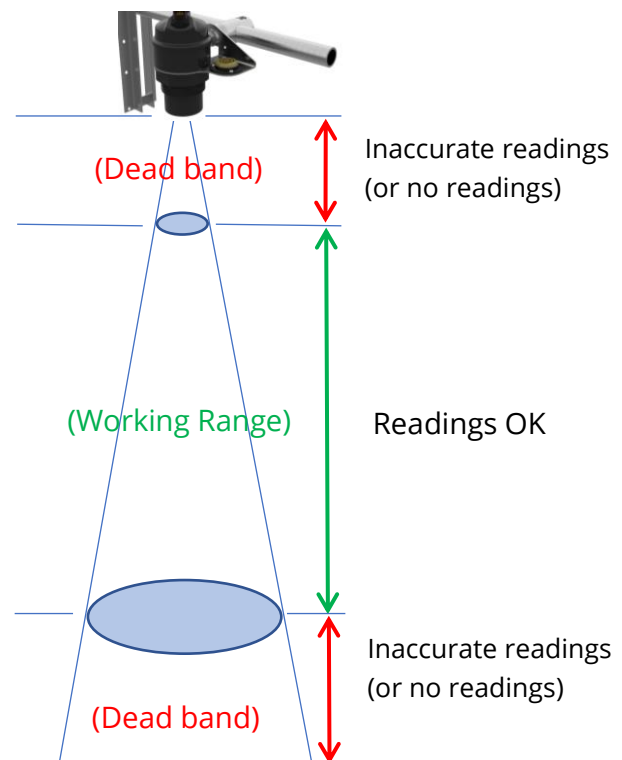



The beam forms a cone of 10 degrees. For optimum results, avoid any unwanted objects within the cone area. The diameter of the beam at various distances from the sensor head is as follows:

Distance (m)	Beam cone diameter (mm)
1	175
2	350
3	525
4	700
5	875
6	1050
7	1225
8	1400
9	1575
10	1750

When installing, obstructions within the cone of the beam should be checked for and avoided.

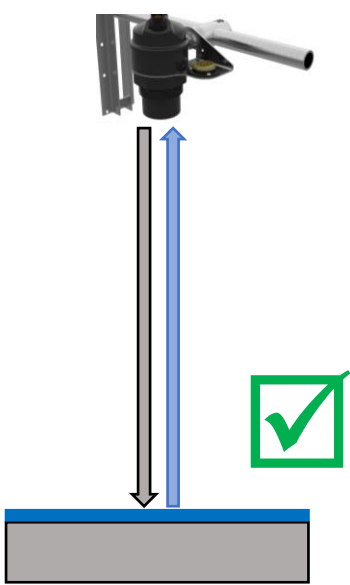
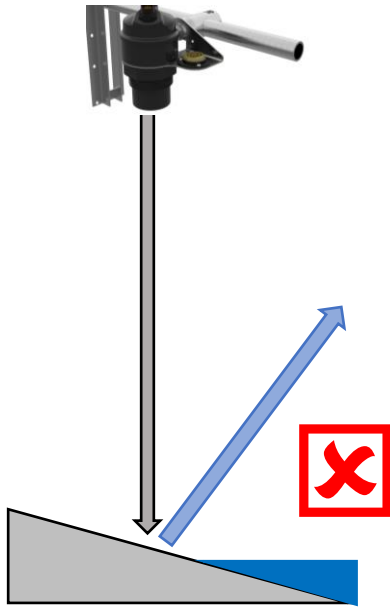
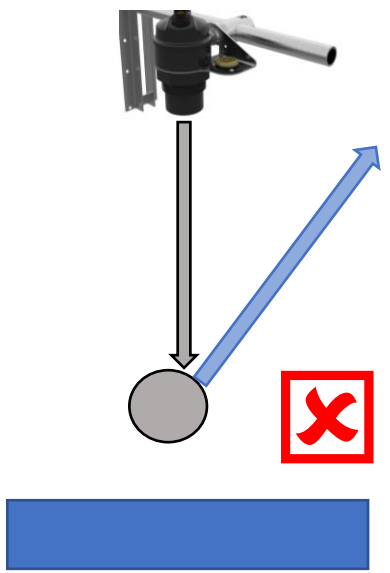
 <p><b>Ideal:</b> The signal has a good flat surface to bounce straight back from, even when the water level is low.</p>	 <p><b>Problem:</b> SonicSens 3 is looking at a sloping (Benched) surface causing the signal to bounce away. This may be a problem that does not appear until the water level is low.</p>	 <p><b>Problem:</b> The ultrasonic beam has struck an object in its path causing all or part of the reflected signal to bounce away. This may be a problem that does not appear until the water level is low.</p>
---	--	--

## 4 INSTALLATION OF IDT / COMMUNICATING WITH THE LOGGER

There are 2 versions of IDT (**I**nstallation and **D**iagnostic **T**ool) available:

- Mobile phone version.
- PC version.

Refer to your logger guide for details of which version of IDT it requires and directions on how to download and install it.

IDT can be set to different operational “user-level” views (which set the available options in the user-interface). The “basic” or “advanced” view is sufficient for checking the setup and the test of SonicSens3.

If the view is not “basic”, the user-level will be shown. e.g., IDT (mobile) shows “User level: Advanced”, opposite.

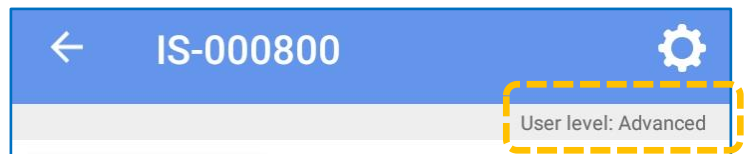

Note: Editing of certain fields may require setting IDT into a more advanced user-level view, which will be password restricted.

The ability to edit certain fields can also be restricted for some users; this is set by your system administrator.

The logger manual will also give instructions for establishing communication with the logger and reading the logger configuration into the memory of the IDT app. You should follow the logger guide for details of how to perform these actions.

This guide picks up IDT usage at the point where IDT shows the main page, as below:

IDT (PC version)

IDT (mobile version)

On IDT (PC), click the button “Read Device” to obtain the configuration from the logger.



Note:

There are some functional differences between IDT (PC) and IDT (app) setup process and logger functions.

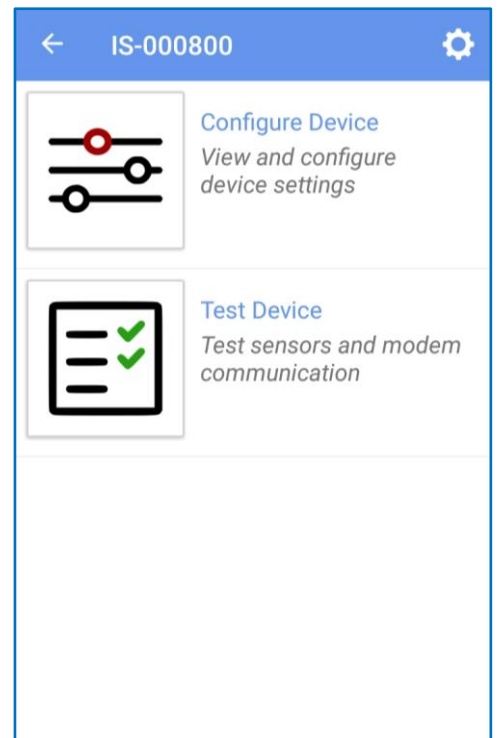

## 5 IDT(PC) SONICSENS 3 CONNECTION AND PRE-INSTALLATION TEST

---

It is recommended to do a pre-installation test to confirm the device is suitable for installation. The steps involved are:

- Connect the SonicSens 3 to the logger
- Confirm the logger recognizes that SonicSens 3 is fitted, using IDT.
- Select a suitable profile. The SonicSens 3 must be set to a suitable profile in order to work correctly. The profile affects the range of the sensor, as well as accuracy.
- Trial the sensor in the proposed installation position.
- If the result looks OK, proceed.
  - i.e.:
    - Complete the installation,
    - Profile adjustments,
    - Setup of measurements,
    - Setup of logged channels.

### 5.1 CONNECT THE SONICSENS 3 TO THE LOGGER

#### IS models (ATEX or IECEx or UKEx marked):

Ensure your logger has a SonicSens 3 interface installed, with a 6-way connector fitted, before attempting installation. This can be determined by the port label on the logger, or from the part-number of the logger. *Refer to your logger's manual for guidance.* Visually check the connector is 6-pin.

Attach the 6-way cable to the 6-pin connector on top of the SonicSens 3. Tighten the cable to ensure a water-tight connection. The cable can fit either way around.



Attach the other end of the cable to the SonicSens 3 input of the logger.

All connectors should be kept free of moisture.

## 5.2 CONFIRM SONICSENS 3 IS RECOGNISED

Connect the logger to the PC using an appropriate cable and adapter.

Launch IDT.

Click on “Read Device”.

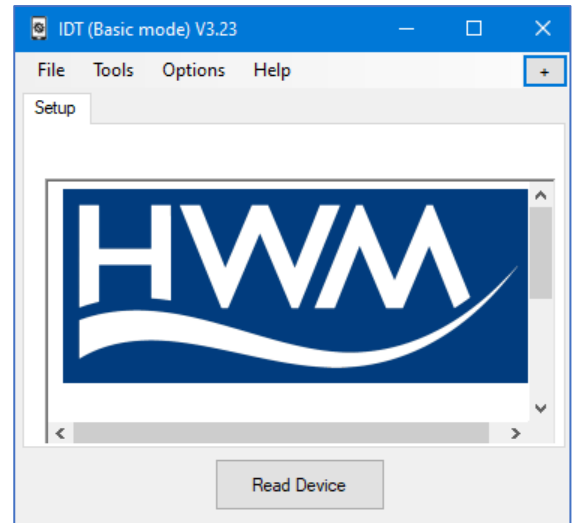

Confirm IDT can read the logger settings.

Select the “Setup” tab and scroll down.

When the SonicSens 3 has been detected by the logger, IDT will display show a “SonicSens Configuration” panel.

The panel shows a pictorial representation of the sensor head.

Note: If IDT does not display this, the SonicSens 3 has not been recognized.

Check the cable is correctly fitted.

Check that you are using the latest version of IDT.

Check the logger has the latest firmware.

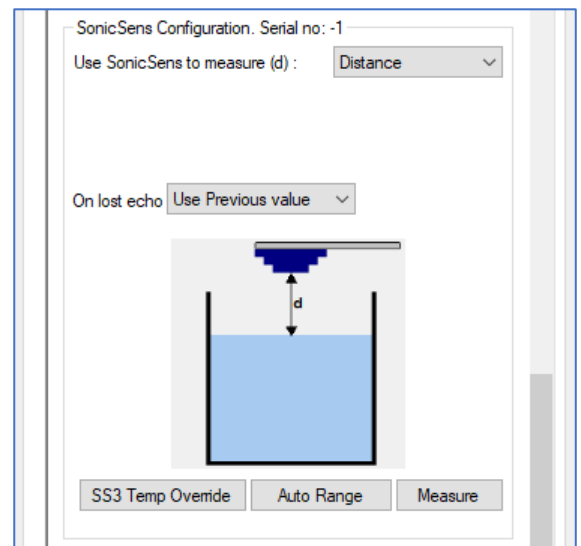

## 5.3 SELECT A SUITABLE SONICSENS 3 PROFILE

Invoke the SonicSens 3 Config window:

Use the menu: Tools → SonicSens Config.

(You must have the SonicSens 3 connected to the logger).

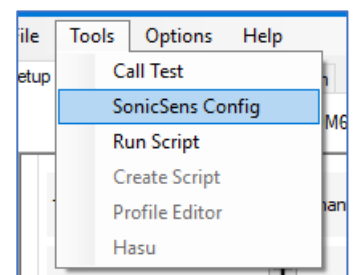

Ensure "Measure Distance" is selected.

Ensure "Use previous value on lost Echo" is selected.

Note the graph display.

This shows the current profile loaded into the logger.

In particular, note the maximum and minimum distance shown on the graph. Irrespective of the rated range of the logger (as on the datasheet), it will not operate if trying to work outside of the profile range (red dots on the graph).

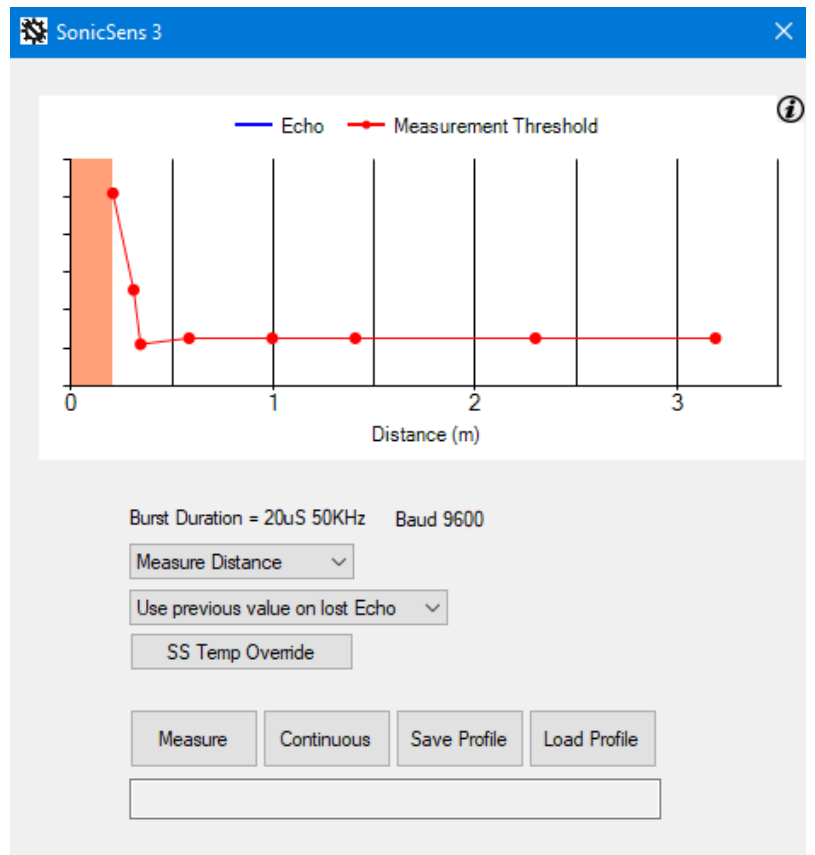

Click the "Load Profile" button.

A selection of standard profiles is listed. Initially, select "Long" as it makes the greatest operational range available for use.

Then click the "Save Profile" button;

This saves the profile settings within the memory of the logger.

Click "X" to close this window.

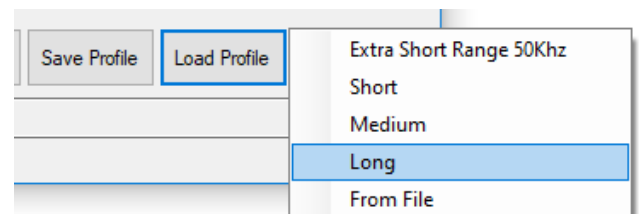

## 5.4 TRIAL THE INSTALLATION POSITION

Hold the sensor in the proposed position of installation. Point it vertically at the water surface. Click on “Measure”.

The text box (below the measure button) shows measurement results. Measurements will be made approximately every 5 seconds, a distance shown, along with a judgement of confidence in the result (shown as a value 0 – 100%).

Stop the test cycle after a few measurements have been made, by clicking on the Stop button.

If no echo is picked up, or the confidence levels are low:

- Check the sensor is pointing downwards.
- Check the sensor is being used within its working range.
- Check the profile (set as the longest range in an earlier step) was saved (re-open the SonicSens Config window to confirm).

If the echo is reflected OK and the received signal has a good confidence level, then stop the test and *Proceed with the installation.*

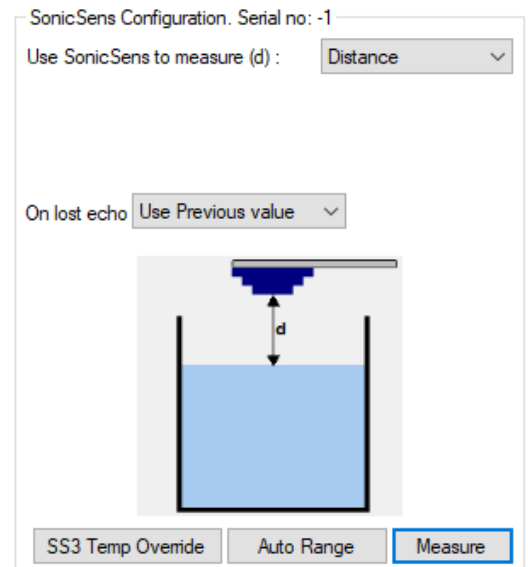

5	Distance 424 mm	100%
4	Distance 432 mm	96%
3	Distance 11331mm	0%
2	Distance 1727 mm	1%
1	Distance 424 mm	100%
0	Distance 424 mm	100%

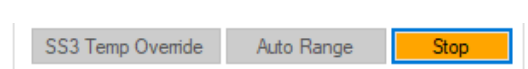

5	Distance 424 mm	100%
4	Distance 424 mm	100%
3	Distance 424 mm	100%
2	Distance 424 mm	100%
1	Distance 424 mm	100%
0	Distance 424 mm	100%

## 5.5 AUTOMATIC RANGE SELECTION FEATURE

This feature causes the logger to run a set of echo tests to find and select (save) the shortest possible usable profile range, based on the current location of the sensor and the body of water beneath it.

This is a one-time process which takes approximately 10 seconds to complete.

To activate the feature, click on the Auto Range button.

A text-display area will appear below the Auto Range button and show the progress of the range evaluation.

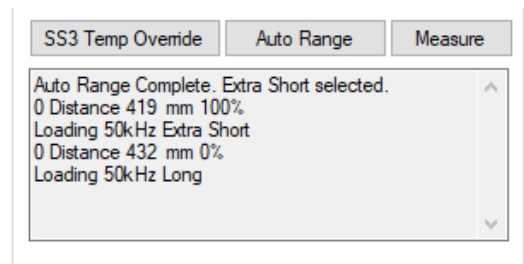
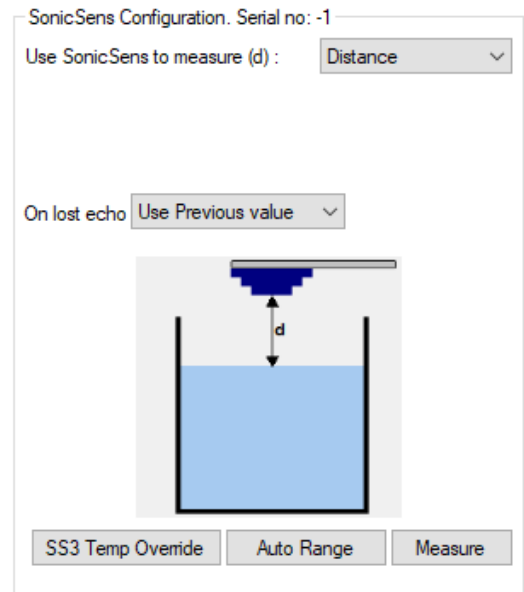

The feature must be used with some caution:

If the water channel is currently empty, the 'Auto Range' button will usually give no issues. However, if a high level of water is present in the channel there is a risk that the selected range may not be adequate to also measure correctly at lower water levels. Therefore, when using auto-range the installer should also check the selected profile is going to be suitable for use when the water is at its minimum level.

## 5.6 TEMPERATURE OVERRIDE FEATURE

The SonicSens 3 is built with a protective resin inside. Therefore, an internal temperature sensor within the unit can take several minutes to adjust to the ambient temperature. If the unit has just come out of cold storage or a hot vehicle, the temperature readings will initially not reflect ambient temperature, and will cause a slight inaccuracy in distance measurements (the sensor attempts to compensate for variations in the speed of sound due to air temperature).

There is a facility to temporarily override the internal sensor (for approximately 60 minutes) and apply a temperature that has been manually entered using IDT.

To activate the feature, click the “SS3 Temp Override” button.

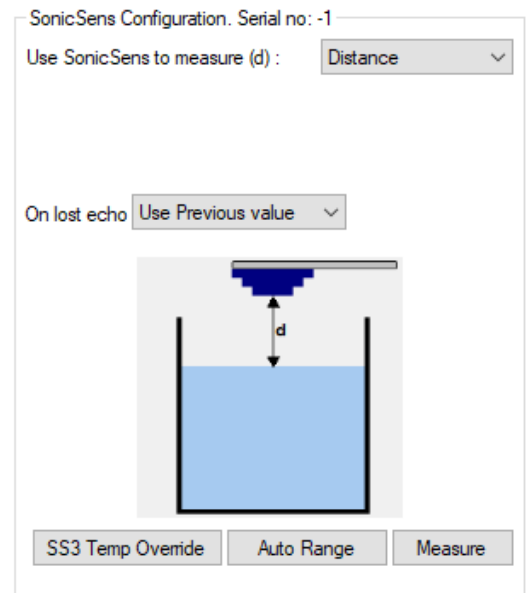

Then enter the ambient air temperature (°C).

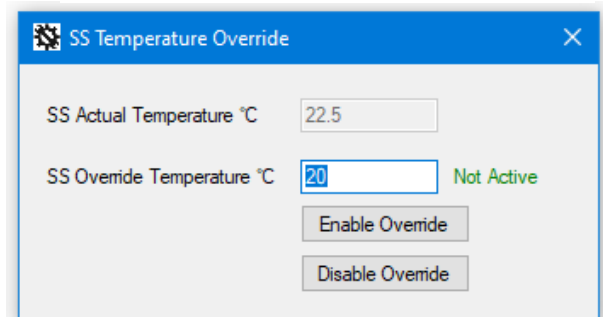

Then click the “Enable Override” button.

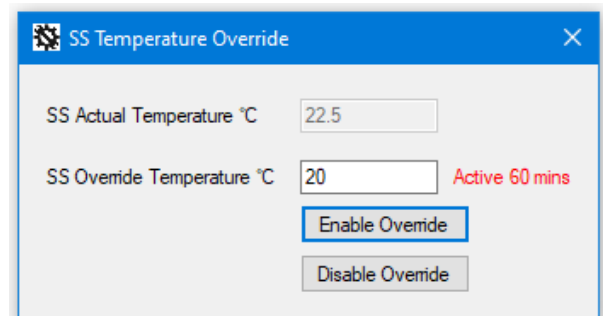

The logger will temporarily use the entered temperature, whilst the sensor temperature settles to the ambient.

Note: Setting the temperature override is not required for most installations. After a short interval the sensor will be at ambient temperature.



## 6 IDT(PC) INSTALLATION OF SONICSENS 3 AND PROFILE ADJUSTMENT

### 6.1 INSTALLATION

Decide on location of the SonicSens 3, a suitable bracket for installation and other accessories.

Drill the side of the chamber and fix the bracket into position with stainless-steel fixings.



Slide a clamp onto the mounting pole (female thread). Position the clamp horizontally.

Tighten the clamp to the pole using a 6mm hexagonal key or bit.

Select a stainless-steel bolt for the front of the clamp. Thread a stainless-steel spring washer, and then a flat washer onto the bolt. Fit the bolt onto the front of the clamp, leaving a gap.

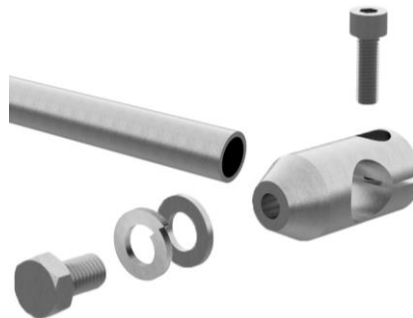

Add the mounting bracket with bubble-level to the SonicSens 3 sensor.

Secure in place with the large plastic nut.

Note: If a submergence shield option is required, it should be fitted along with its O-rings prior to fitting the plastic nut.



Using the key-hole slot in the bracket, slide the bracket onto the clamp.

The two washers should be between the bracket and the head of the bolt.



Once in position, use the bubble-level to adjust the sensor until it is level. Then tighten the bolts using a 19mm spanner.



For wide chambers, two brackets should be used, along with a tubular pole to bridge the gap. Several pole lengths are available.

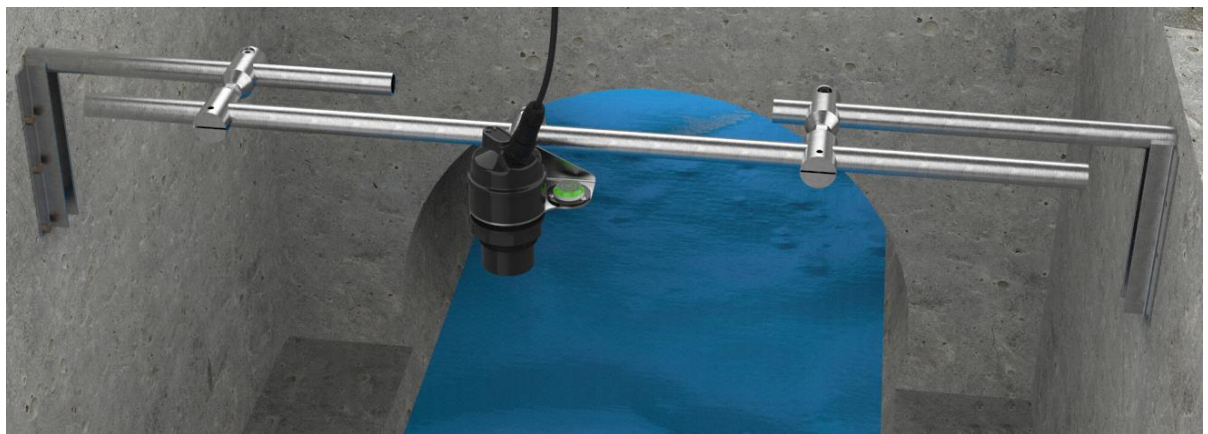

The clamps are available in male and female versions; a pair is required to attach one pole to another, plus a nut, at each support point.

Thread the nut onto the male thread first, then thread the pair of clamps together.

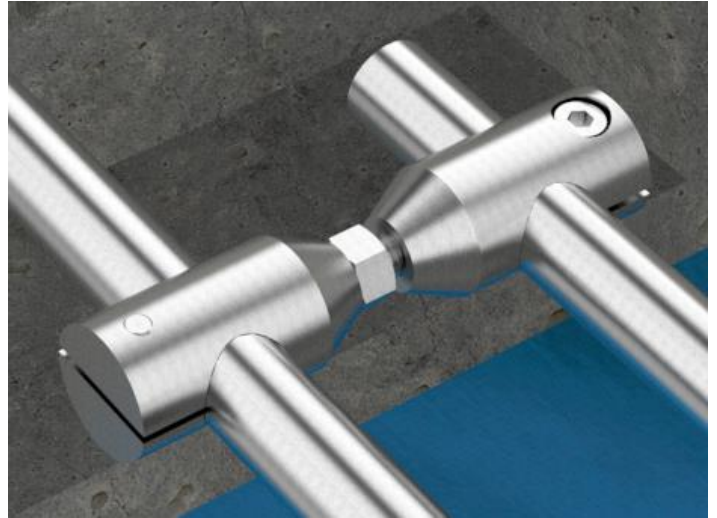
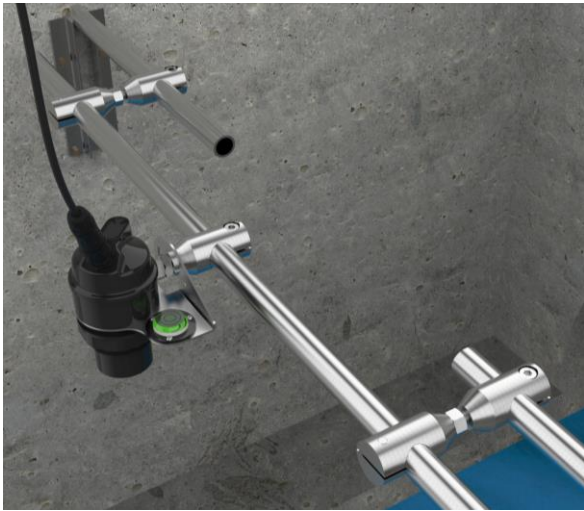

When the pole is in position, the nut should be tightened to secure the assembly.

For small chambers, there may be a requirement to swivel the sensor out of the way to provide access into the chamber.

Use a hinged bracket in these situations. Left-turn and right-turn hinged brackets are available.

After completing work, the hinged bracket can be returned to its regular position.

(The sensor must be leveled in its regular position).

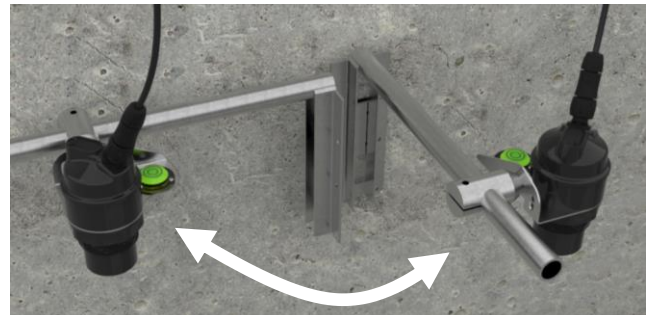

When there is risk of flooding within the chamber, a submergence shield option is available (2 sizes, dependent on SonicSens 3 model).

Fit as shown opposite. Use O-rings to form an air-tight seal.

The shield will prevent any debris attaching to the sensor, which could affect its functioning and require it to be cleaned.



Where the chamber is shallow, the dead band near the sensor may cause range problems. Inquire to HWM whether a stainless-steel deflector plate could be used (not shown). When used, the SonicSens 3 is mounted horizontally and targeted at the centre of the deflector plate, which must be mounted near to the sensor (approx. 0.45m, max) and at 45 degrees, reflecting the beam of the unit downwards.



## 6.2 PROFILE ADJUSTMENT

During initial configuration for position tests, the SonicSens 3 was put into a mode that measured distance with greatest available range. Note that, whilst the logger is now aware of the measurement device, it is not actually requesting measurements from it or logging any measurement data. This requires logger *data channels* to be set up, which will be done later – see section 8.

The SonicSens 3 settings now need to be tuned to the conditions of the installation location.

Select “SonicSens Config” from the menu.

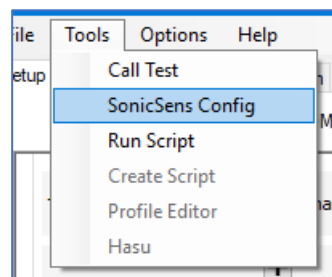

Click on the “Load Profile” button.

Select the most appropriate option for the installation.

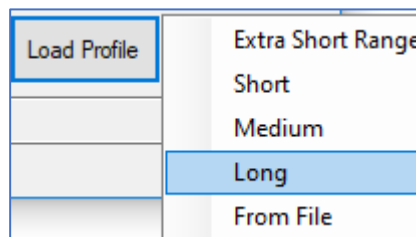

The “most appropriate” selection depends on the expected range of water levels.

- Measure from the lowest part of the sensor to the bottom of the water channel; This will effectively give you the maximum distance that needs to be measured.
- Measure from the lowest part of the sensor to the highest expected water level; This will effectively give you the minimum distance that needs to be measured.
- The “Long” profile gives the greatest range, but at shorter distances accuracy will be less. The burst of pulses in this range takes longer to send, which causes the dead band nearest the sensor to increase.

Choose the most appropriate standard profile for the range of distances (min to max) that needs to be covered. Then click on “Save Profile” to save it to the logger memory.

Having chosen the appropriate standard profile, **which should be OK for most installations**, the reliability of the echo can now be checked.

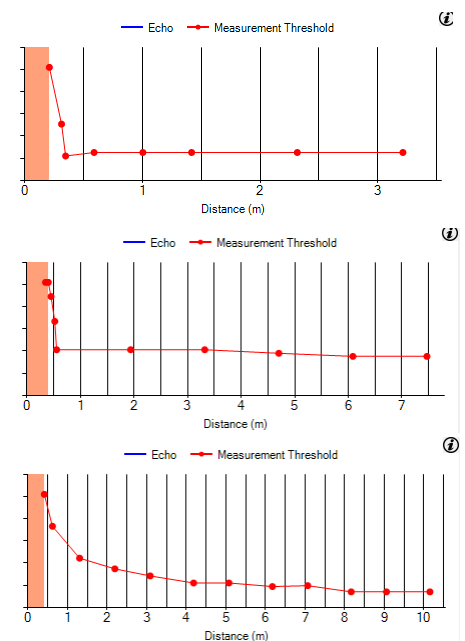

### 6.3 ECHO CHECK / THRESHOLD ADJUSTMENTS

Use the menu: Tools → SonicSens Config.  
(You must have the SonicSens 3 connected to the logger).

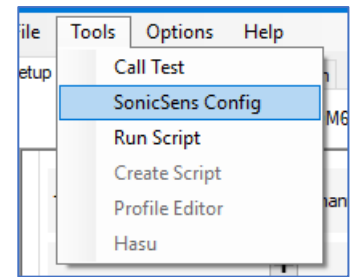

Ensure "Measure Distance" is selected.

Ensure "Use previous value on lost Echo" is selected.

The current threshold mask is shown (red dots and line on the graph).

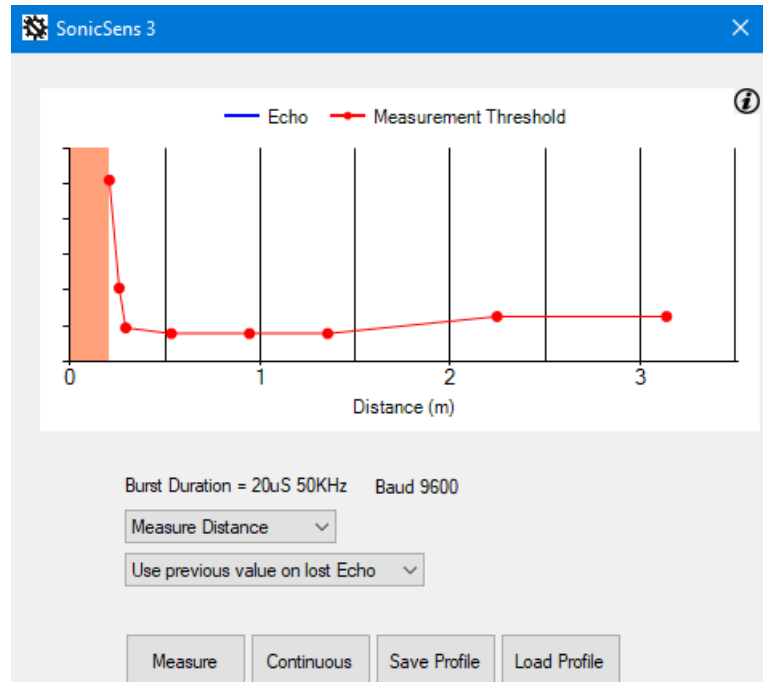

Click the "Measure" button.

The logger instructs the SonicSens 3 to make a measurement.

The distance result is shown in the text box (along with the sensor temperature, which is not relevant at this point).

The echo obtained by SonicSens 3 can be seen graphically.

The echo response is shown in blue, showing a peak. There is a vertical green bar at the distance identified as the distance to the measured water surface.

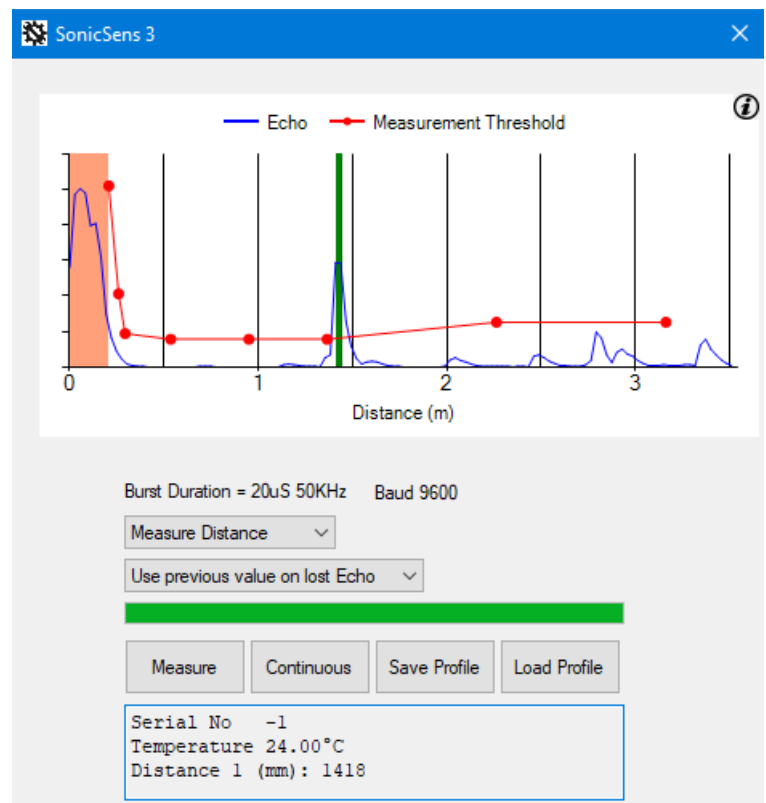

Further along the blue trace there are smaller peaks which represent the echoes that have taken alternative paths to return to the sensor.

The red line shows the threshold line for an echo to be recognized. This line is adjustable, by dragging the dots. When happy with the results, click on “Save Profile” to store them in the logger.

In the graph shown (above), the area before the first peak / green bar is clear of any echo, which is ideal. If there is a small object close to the beam (e.g. a cable) it is possible that it gives an echo that arrives before the true measurement. Wherever possible, the interfering object should be moved. If it cannot be moved, the thresholds can be adjusted to ignore the early echo (drag the dots above the peak). Caution is required however, since it could introduce an additional dead-band for the sensor where measurements cannot be made. Any changes made should be minimal.

Adjustment of the threshold can also be made if the reflected signal is a low peak (due to a turbulent water surface) and is occasionally unreliable. Lowering the threshold slightly may give improvements but should only be used if the standard profiles do not give reliable results. The graph is just one example of the several samples it makes to get a measurement.

Click the “Continuous” button to make repeated measurements to confirm the reliability of the measurement.

Each time it measures, SonicSens 3 sends several bursts of ultrasound, and calculates statistically where the peak is. It is therefore able to compensate for some turbulence at the water surface. Even though the echo response crosses the threshold line at longer distances (see graph opposite), they are ignored because the peak nearest the sensor is the more direct path.

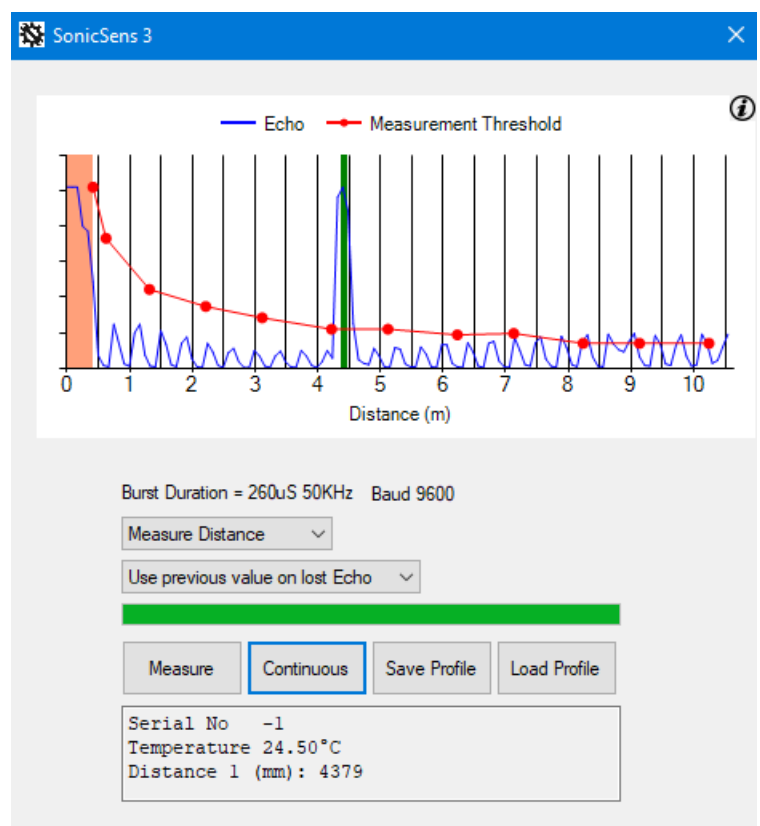

For most situations, loading one of the profiles from the menu gives good results, and no further adjustments are needed.

For further confidence test, repeat the IDT measurement described in section 5.4, which should now show very repeatable results.

Profile adjustment is now complete. If the SonicSens 3 is replaced with a model which has a different range, the process should be repeated from section 5.1.

## 7 IDT(PC) SETUP OF BASIC MEASUREMENTS

### 7.1 MEASUREMENT OF DISTANCE

SonicSens can directly measure distance.

Use the drop-down box to select "Distance".

Two options exist to determine the response of the SonicSens if an echo is lost. Either the previous value or a user defined fixed value can be used.

When finished, save the settings by scrolling down to the lowest part of the screen and clicking on "Setup Device".

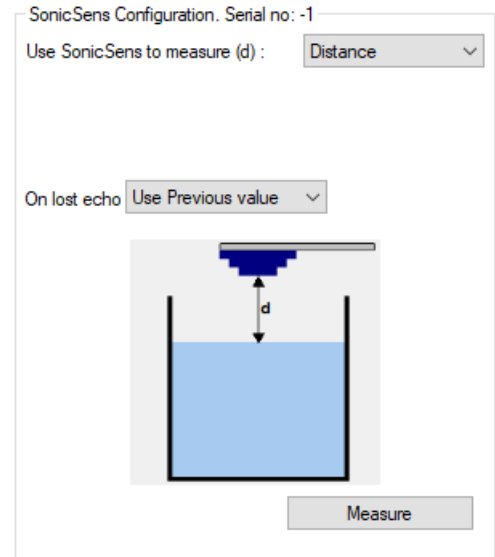
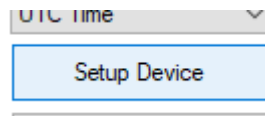

### 7.2 MEASUREMENT OF DEPTH

SonicSens can indirectly measure depth.

Use the drop-down box to select "Depth".

Measure the distance from the bottom of the sensor to the bottom of the channel, in mm. Input this value into the "Distance Channel Bottom to Sensor Head (h)" text box.

Graphically, the measured distance, "d", is now shown as between the bottom of the water channel to the surface of the water.

This is a result formed by calculating the difference between the distance to bottom of the channel and the distance to the surface of the water.

Click on Measure and confirm the results obtained make sense, then stop the measurement by clicking on the same button.

Two options exist to determine the response of the SonicSens if an echo is lost. Either the previous value or a user defined fixed value can be used.

When finished, save the settings by scrolling down to the lowest part of the screen and clicking on "Setup Device".

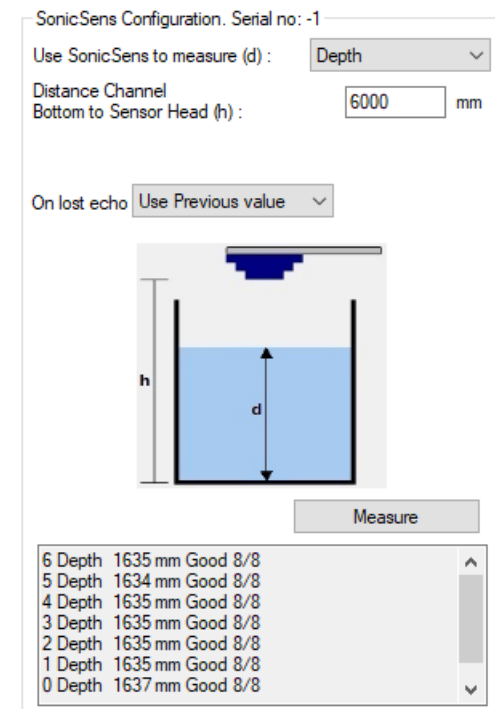
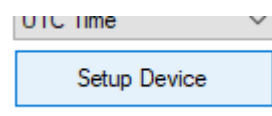



## 8 IDT(PC) LOGGING BASIC MEASUREMENTS – SETUP OF DATA CHANNELS

Having set the SonicSens 3 to work correctly, the logger needs to be set up to periodically make measurements using the device.

The “Logging parameters” panel in IDT shows a field called “Sample Interval”. This can be adjusted to set the basic measurement sample period. At each sample interval, the logger will activate the SonicSens 3 and instruct it to make a measurement. Similarly, any other transducers the logger has will also be activated to obtain data samples at the same sample rate.

The logged data is not always the same as the sampled data. The logger can be set to look at multiple samples and then make a calculation on them in order to produce a logged data-point. The time interval for this is set using the “Log data at specified time interval” settings.

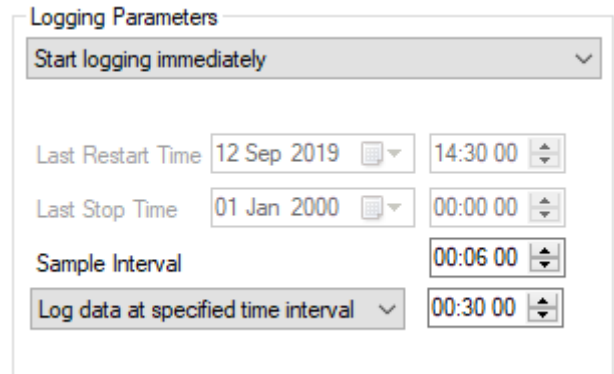

### 8.1 DISTANCE OR DEPTH

If the logging activity is not already set up, click on the “+” button in the “Logging Channel” panel.

An unassigned Logging Channel is created.

The channel number is shown on the left. This will be the “channel number” that the data arrives within when it arrives at the DataGate server.

Click on the cog button.

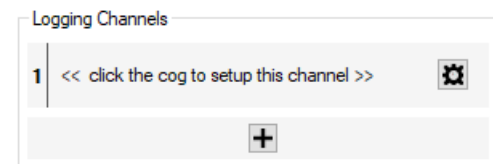
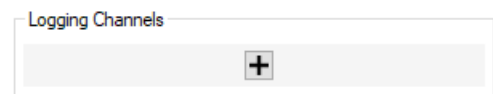

Click on the “Input Sensor” selection box.

Select “SonicSens Measurement”.

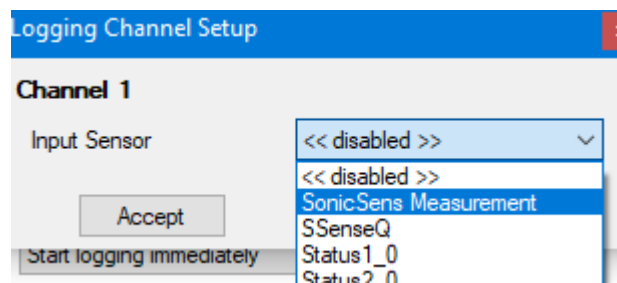

Click on the "Sensor Type" selection box.

Select "Depth"  
(or "Distance" if that was set earlier).

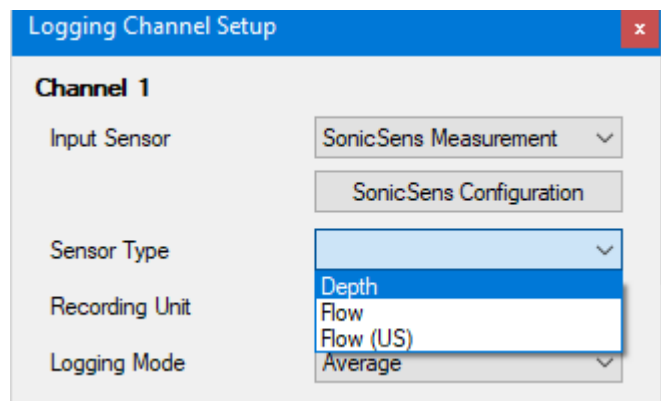

Select the "Recording Unit" as mm, which is the unit of measure used by the SonicSens 3.

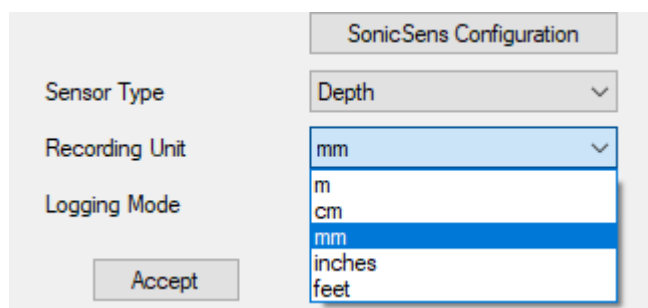

Select the required "Logging Mode".

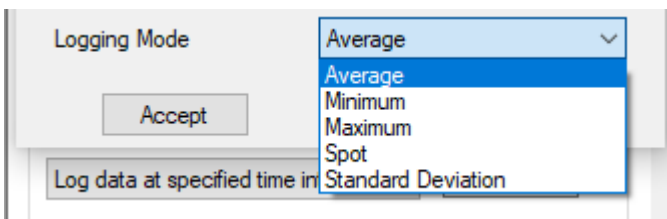

Spot = Single sample made at the Logging Rate (no other samples are made).  
Minimum = Minimum of all samples taken between now and the previous log time.  
Maximum = Maximum of all samples taken between now and the previous log time.  
Average = Average of all samples taken between now and the previous log time.

Click on the "Accept" button.

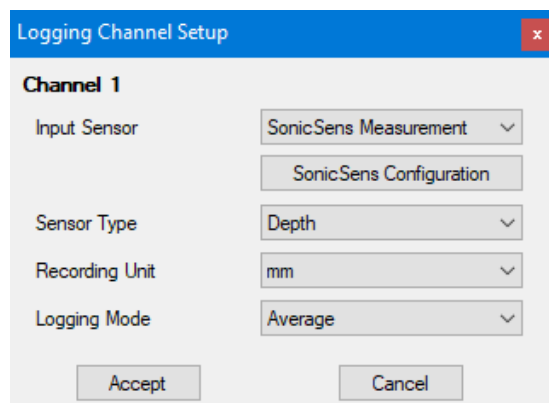

The logging channel has now been set up.

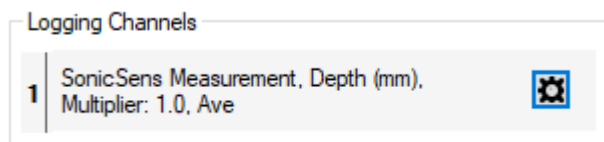

Save the settings by scrolling down to the lowest part of the screen and clicking on "Setup Device".

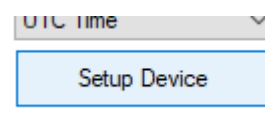

Note: The multiplier must be set to “1.0” for the channel. If incorrect (as shown opposite), it can be adjusted by following the same setup instructions but must be done using the “Advanced” setting of IDT.

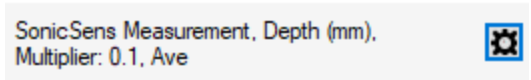

## 8.2 MEASUREMENT QUALITY (OF DISTANCE) MONITORING

In a similar manner to 8.1, a channel can be set up to monitor the quality of the SonicSens 3 data.

This is a measure derived from the number of “good” and “bad” measurements that were obtained from the measurement system of SonicSens 3.

For this, select an Input Sensor of “SSensQ”.

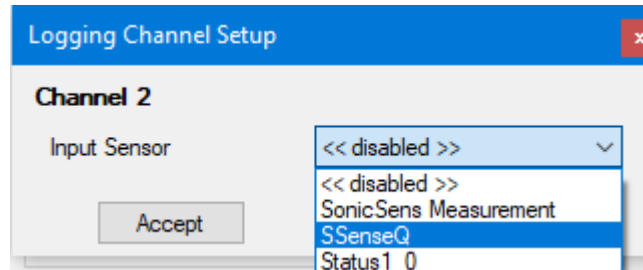

Select the other settings as shown opposite.

Then click on “Accept”.

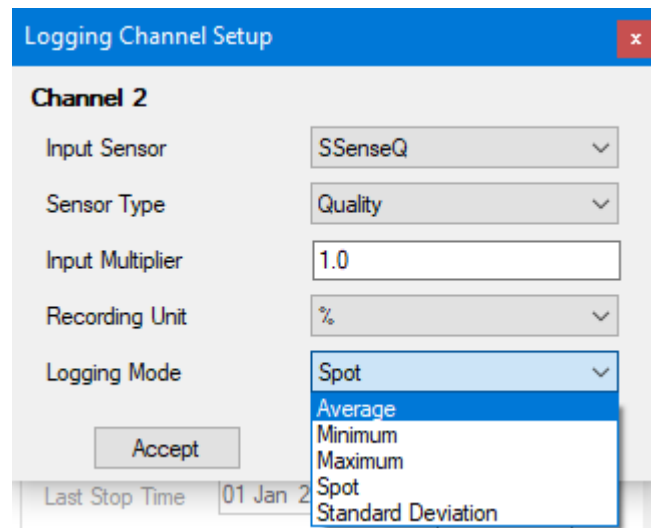

The channel is added to the list of those being logged.

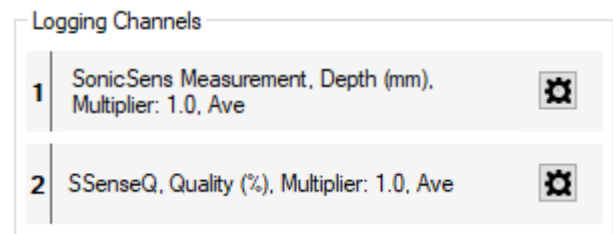

Save the settings by scrolling down to the lowest part of the screen and clicking on “Setup Device”.

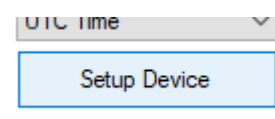

## 9 IDT(PC) SETUP OF ADDITIONAL MEASUREMENTS

### 9.1 FLOW OF WATER FROM A WEIR

The SonicSens 3 can be used to indirectly measure the water flowing from a weir. This requires the SonicSens measurement to be used as an input to the “Open Channel Flow Setup” panel (also called the FlowOCH channel). This channel requires the geometry of the weir to be entered. It then acts as a flow calculator, converting the depth of water into a flow calculation. SonicSens 3 can provide the necessary depth of water to be input into the calculation.

Select the Setup tab and scroll to the “Open Channel Flow Set-up” panel.

From the “Conversion table” selector, choose “Depth/Flow (Weir)”.

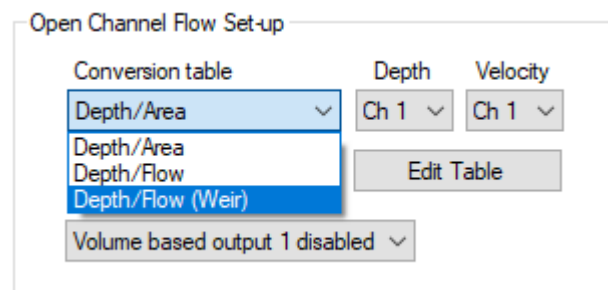

The depth input can come from any viable source. Use the “Depth” selector tool to map the depth input to one of the Logging channels.

In the example in this manual, SonicSens 3 depth is being logged as Channel 1, so “Ch 1” must be selected.

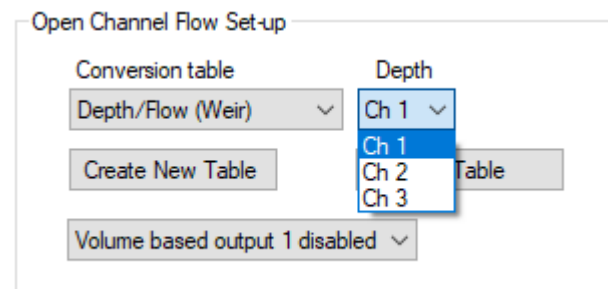

Weirs can have different shapes. Click on “Create New Table” to begin the process of entering the geometry of the weir.

Note: The depth of the water is measured from the bottom of the water channel. The weir blocks the flow of water until its depth exceeds the minimum height of the weir. This point is known as the “crest”. This, and other dimensions need to be measured from the-site.

Select the Weir Type.

3 options are available.

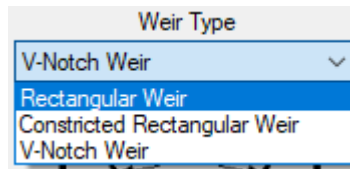

Enter the measurements required, according to the selection made.

When finished, click on "Save".

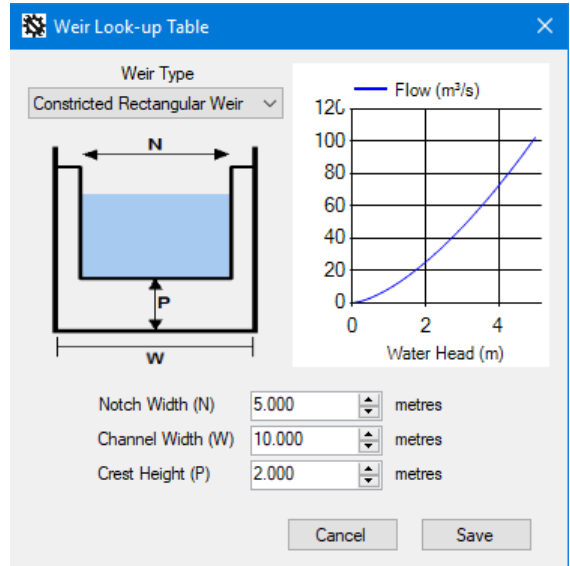
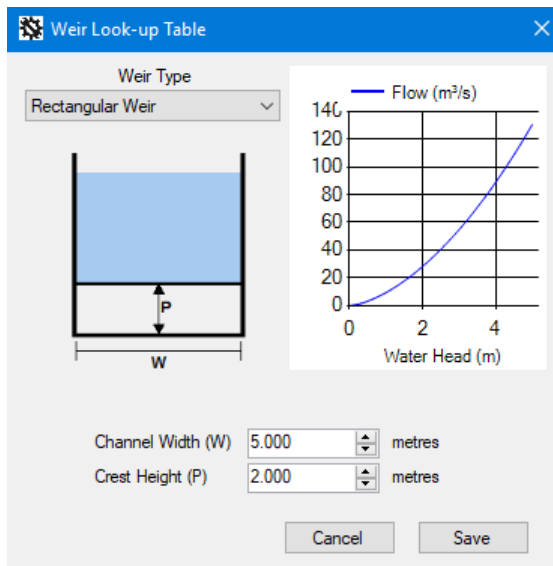
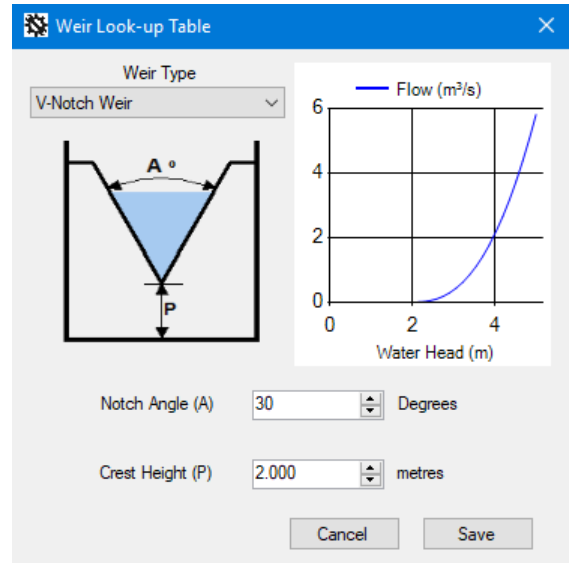

For a weir of a different shape to the above options, but where the "depth to flow" characteristics are known, they can be entered in tabular form.

Change the selection to "Depth / Flow".

Then click on "Create New Table".

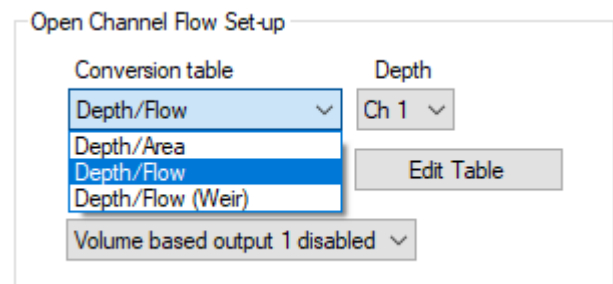
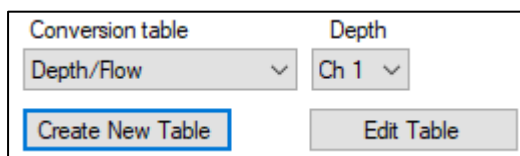

Enter the Depth / Flow characteristics.

(There will be no flow until the crest is reached, then flow will increase with increasing depth).

Click in the dotted box to add a new line. Click any other box to edit.

- The depth must be entered in mm.
- The flow rate must be entered in m<sup>3</sup>/s.

(Using one of the standard weir shapes, described earlier, calculates and produces such a table from the entered geometry).

When finished, click on "Save".

	Depth in channel (mm)	Flow in channel
▶	0	0
*		

	Depth in channel (mm)	Flow in channel
	0	0
	100	0
	200	0
▶	300	0.002743084
	400	0.008399513
	500	0.01807222
	600	0.03246019
	700	0.05229231
	800	0.07785564

## 9.2 FLOW OF WATER THROUGH AN OPEN CHANNEL

If the SonicSens 3 is used with a logger that also has a means of measuring the velocity of the water, the flow can be calculated.

Flow (i.e. volume) = cross-sectional area of water X velocity X time.

In the Open Channel Flow Set-up panel, select a Conversion Table of "Depth / Area".

Then click on "Create New Table".

The cross-sectional area of the water depends on the shape of the water channel and the depth of water. Depth of water is also affected by any sediment in the channel.

The cross-sectional area of the channel (which should also be where the velocity is measured) can be input in graphical form, which is converted to a table. Channel shapes can be built-up from basic shapes stacked on top of each other.

For instance, the shape below consists of a trapezoid plus a rectangle.

Enter the lowest part of the channel first, followed by subsequent changes in shape to build up the over-all shape of the channel.

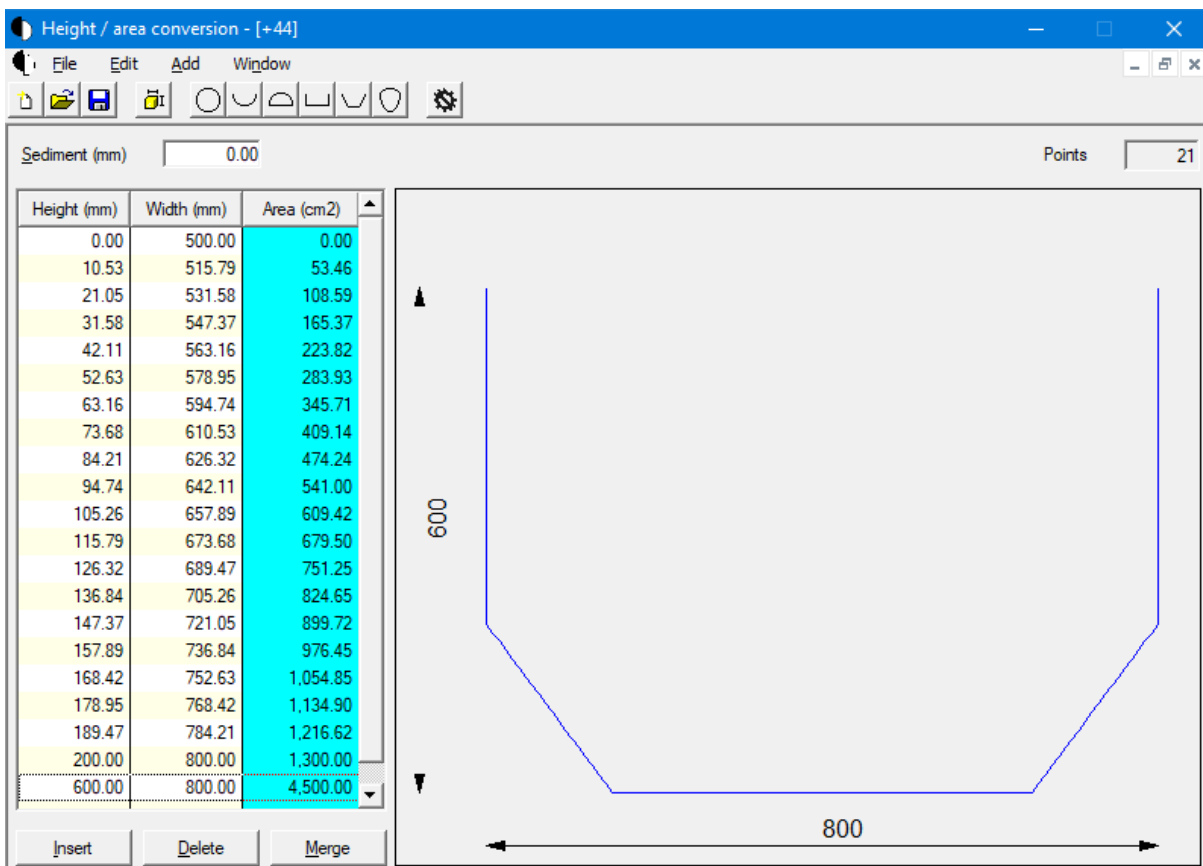
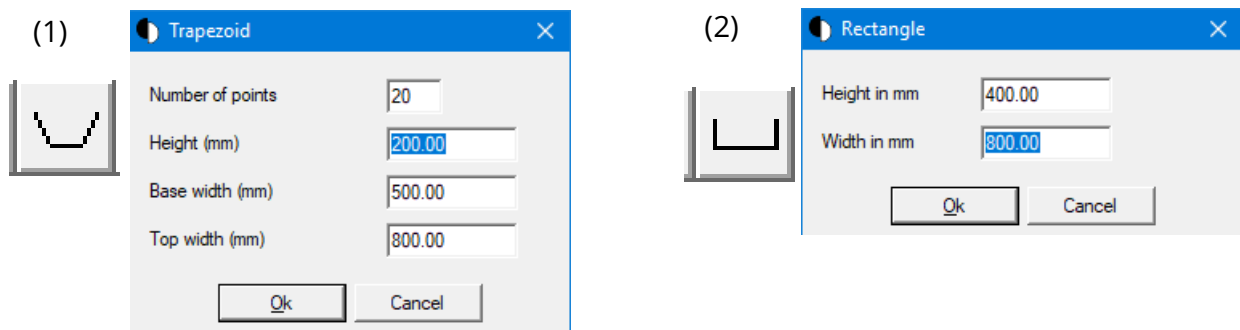

The table is automatically completed from the shape and dimensions. It can be further adjusted by inserting lines or deleting lines from the table. The cells with height and width data can be edited.

A sediment depth can be added to reduce the area.

The cross-sectional area description can be saved to the PC if required, for later use.

The cross-sectional area description must be saved to the logger using the "Transfer Data" icon.

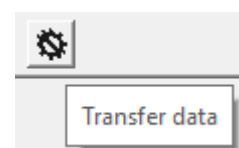

Complete the setting by choosing the logging channel number that is recording the velocity measurement (i.e. Ch 3, in our example).

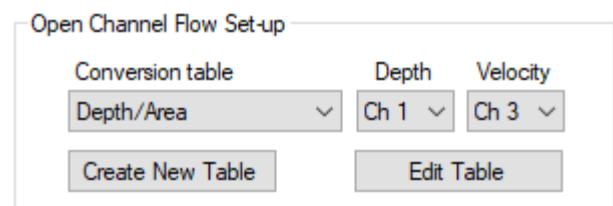

## 10 IDT(PC) LOGGING ADDITIONAL MEASUREMENTS

The additional measurements (see section 9) used the FlowOCH (Open Channel Flow) calculator. In order to log the calculated results, a Logging Channel must be set up.

Click on the “+” icon within the Logging Channels panel.

Click on the cog icon to setup the logged data channel.

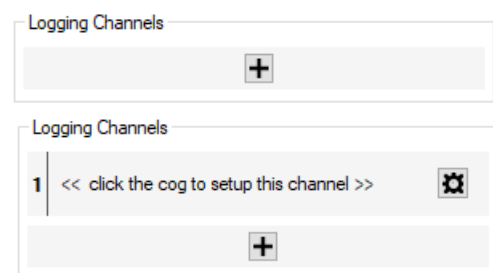

Select “Flow OCH” as the “Input Sensor” (although it is actually a calculator, dependent on the input from other sensors).

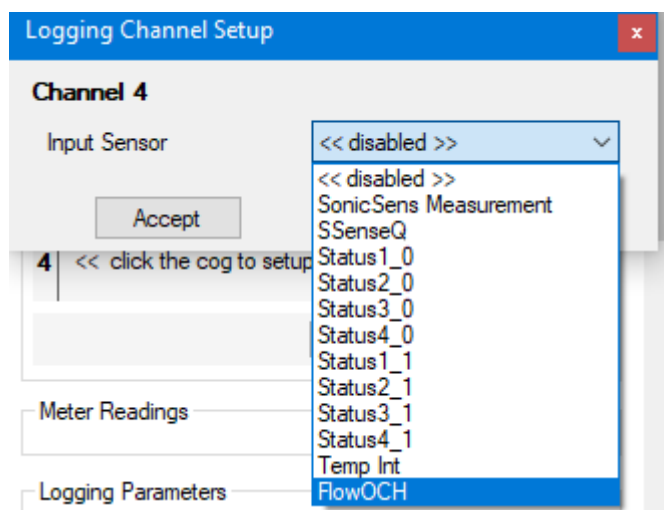

Set the “Sensor Type” to “Flow”. (This also determines what Units of measure are available within the Recording Unit selector).

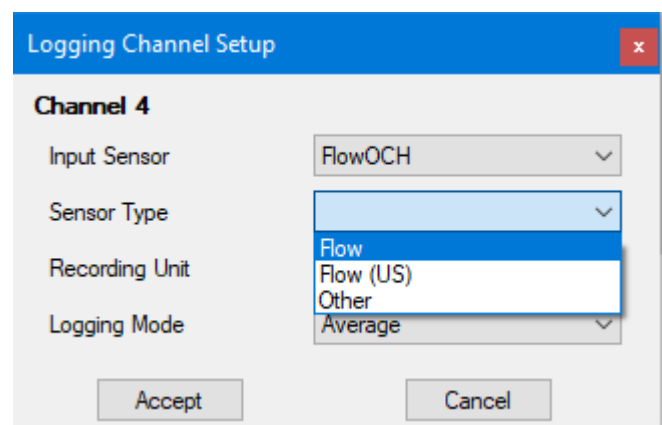



Select the recording unit as required, e.g. m<sup>3</sup>.

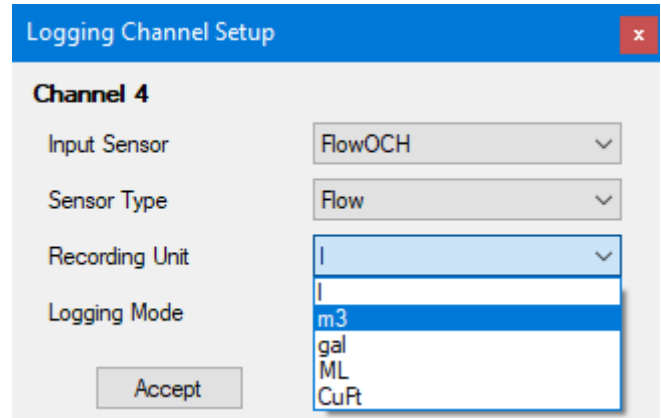

Select an option for the logging mode.

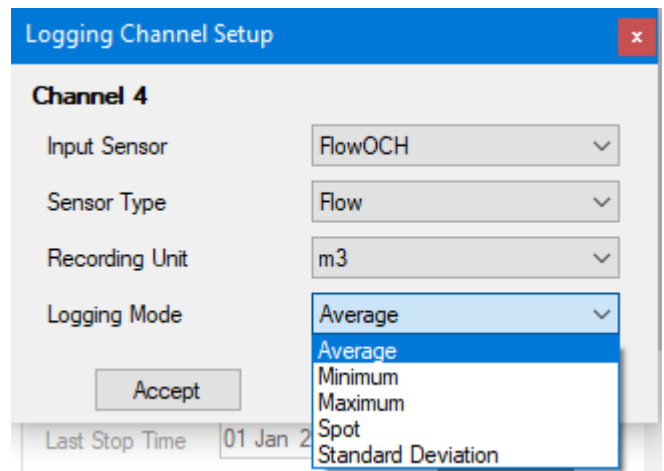

When the selections are complete, Click on "Accept".

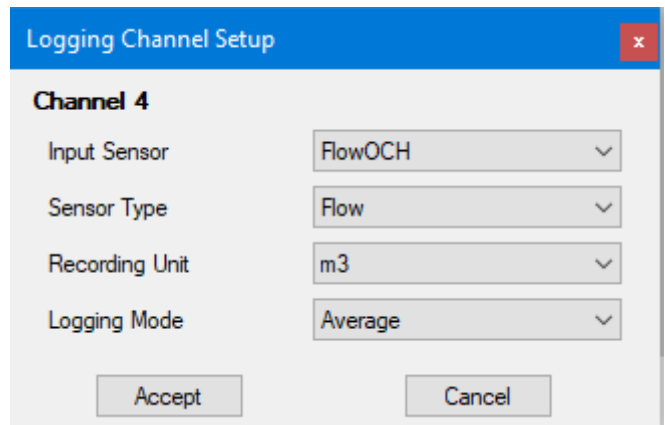

The settings are summarized in the panel.



Save the settings by scrolling down to the lowest part of the screen and clicking on "Setup Device".

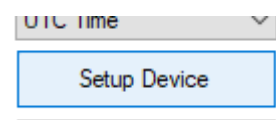

## 11 IDT(PC) SETUP OF ALARMS

Measurement results that are logged can be checked for a variety of conditions that should cause an alarm. Setup of and monitoring for an alarm condition is a general logger function, not specific to SonicSens 3.

Consult the IDT manual for how to setup an alarm condition on a channel.

## 12 IDT(PC) ADDITIONAL OPTIONS

### 12.1 VOLUME-BASED PULSE OUTPUT

Where supported by the logger model, it is possible for the logger to generate a pulse of 1-20s duration on an output of the logger. The timing of the start of the pulse is based on a set volume of fluid being measured. The pulse repeats each time the specified volume of fluid passes. The output pin can be used to activate external (unspecified) equipment.

For loggers supporting this feature, the volume and timing of the pulse can be set as follows:

In the Open Channel Flow Setup panel, Select "Volume-based output 1 enabled".

Set the required pulse duration and the number of units of volume required to pass to activate each pulse event.

## 12.2 SONICSENS 3 TESTS

Live data from SonicSens 3 can be displayed using the “Hardware Tests” tab.

Click on “Start Test”. The data will be displayed along with the data of other fitted channels.

The battery voltage is relevant to SonicSens 3, as it is powered by the logger battery.

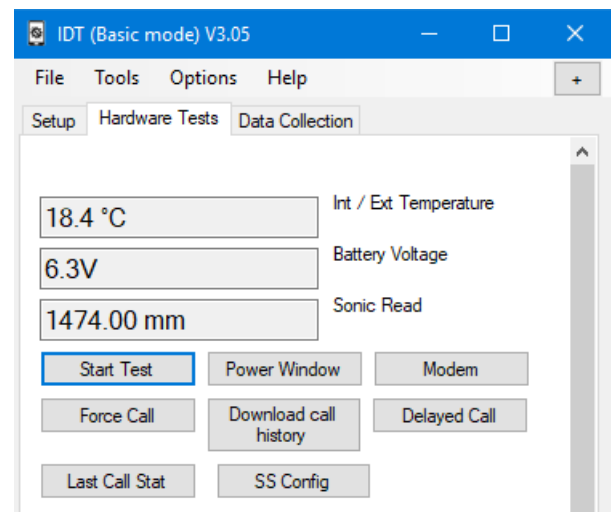

## 13 IDT(APP) SONICSENS 3 CONNECTION AND PRE-INSTALLATION TEST

It is recommended to do a pre-installation test to confirm the device is suitable for installation. The steps involved are:

- Connect the SonicSens 3 to the logger
- Confirm the logger recognizes that SonicSens 3 is fitted, using the IDT app.
- SonicSens3 can produce several types of measurement data.  
Set the logger to read relevant data from SonicSens3.
- Install the sensor in the required installation position.
  - Select the required measurement mode (distance or depth).
  - Profile adjustments (range, echo thresholds)
  - Setup of any additional measurements (open channel flow)
  - Setup of logged channels.

Note: Some loggers may have more than one SonicSens3 interface fitted. Where this is the case, the IDT app will enumerate the available sensors as follows:

- SonicSens3
- SonicSens3 2
- SonicSens3 3

### 13.1 CONNECT THE SONICSENS 3 TO THE LOGGER

(Refer to section 5.1)

### 13.2 CONFIRM THE SONICSENS 3 IS RECOGNISED

If using the app version of IDT, follow the guidance in the logger manual to temporarily activate its Bluetooth® communications link.

Connect IDT to the logger which is being installed over the Bluetooth® radio link (follow the guidance in the logger manual).

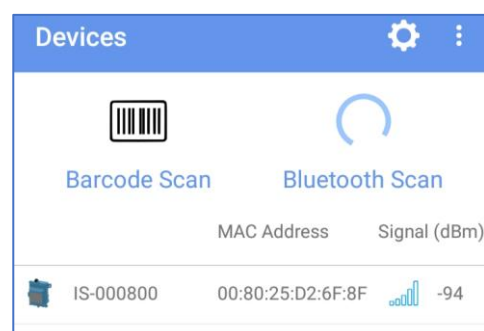

Tap on "Test Device".

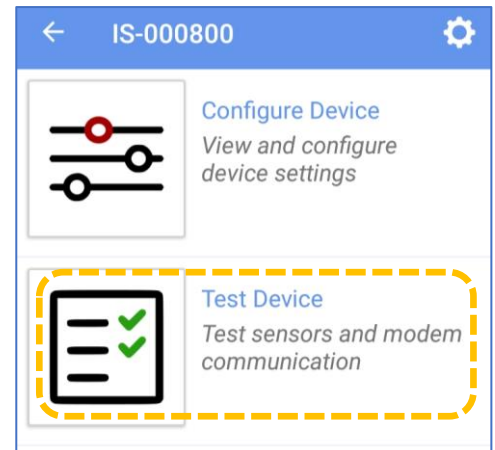

Then tap on "Hardware Test".

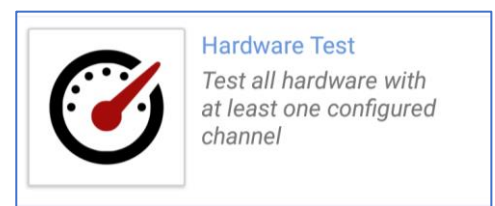

Check the result shown on the "SonicSens Measure" line. A numerical reading indicates the sensor has been recognized by the logger.

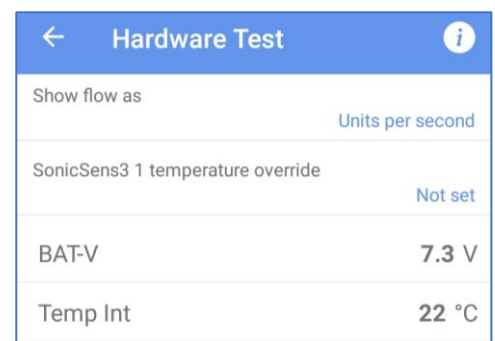

Note: If IDT does not display a "SonicSens Measure" line, the logger may not have the channel fitted, or it may not yet be setup; see sections 14 and 16.

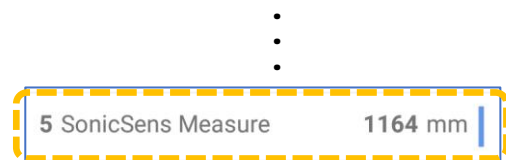

When the SonicSens 3 has not been detected by the logger, IDT will display show a "Error reading sensor" message. (This is a general-purpose error message and not exclusively used for an undetected sensor). Alternatively, a "Lost comms" message may be shown.

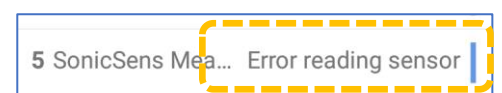

(The error message may not appear for the first 2 minutes, as the logger may be set up to initially substitute data. The message may also appear occasionally during hardware test if there is some temporary measurement issue such as an expected echo being lost).

## 14 IDT(APP) SETUP OF LOGGER TO READ DATA FROM SONICSSENS3

### 14.1 DISTANCE

Note: If the SonicSens 3 is recognized by the logger and is already set to measure distance (see section 13.2), this section can be skipped or used as a reference to confirm or adjust any settings to the local installation needs.

This section describes how to setup the logger for making it function with SonicSens 3 for the purpose of obtaining distance measurement data.

From the main options screen, tap on Configure Device.

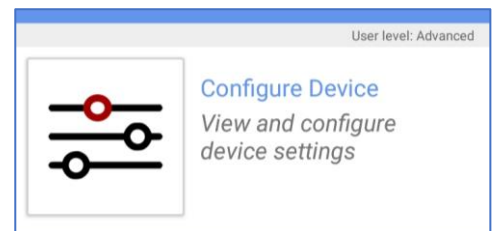

A new options selection page will appear.

Tap on "Channels".

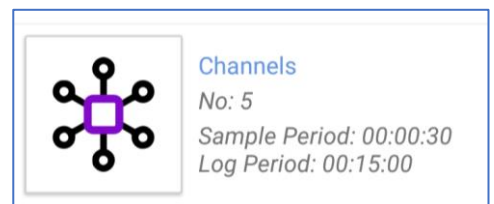

If the logger is already setup, the SonicSens 3 will be listed amongst any other sensor channels. (Shown as 'SonicSens Measure').

The diagram opposite shows a distance measurement (and an internal temperature measurement) from the sensor already set up.

(If you tap on a line, settings can be edited).

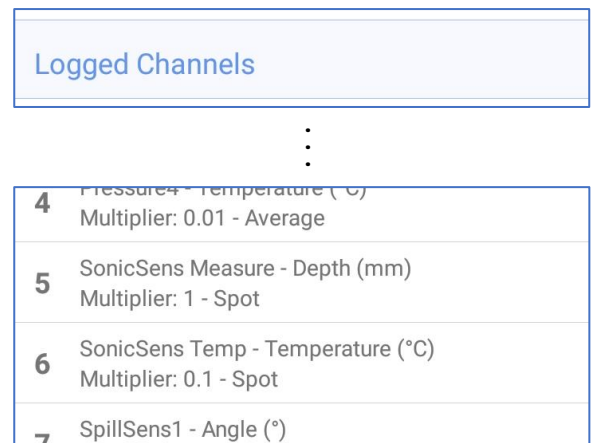

If the logger has not been set up for depth (distance measurements), tap on the "+" control to add a new channel. The logger must be set up to obtain distance data from the sensor.

(See also the IDT manual for additional guidance).



Tap on the Input Sensor line and choose the relevant interface (shown options depend on how many SonicSens3 interfaces are fitted).

- SonicSens3
- SonicSens3 2
- SonicSens3 3

Input Sensor	<Disabled>
Sensor Type	
Recording Unit	
Logging Mode	Off

Select an Input Sensor of “SonicSense Measure [n]” for distance measurements.

<b>Input Sensor</b>
BAT-V
⋮
Pressure4
<b>SonicSens Measure</b>
SonicSens Qual
SonicSens Temp

Tap on the Sensor Type line.

User level: Advanced	
Input Sensor	SonicSens Measure
Sensor Type	
Input Multiplier	1
Offset	0
Recording Unit	
Logging Mode	Average

Select “Depth”.  
(This means any distance measurement).

<b>Sensor Type</b>
<b>Depth</b>
Flow

Tap on the Recording Unit line.

Select the desired unit of measure (e.g., mm).

Offset should be set to "0".

Input multiplier is normally set to "1".

Recording Unit
m
cm
mm
inches
feet

Input Sensor	SonicSens Measure
Sensor Type	Depth
Input Multiplier	1
Offset	0
Recording Unit	
Logging Mode	Average

Tap on Logging Mode and select the required mode.

(Normal logging mode for SonicSens 3 is for a single instantaneous reading; select "Spot").

Logging Mode
Average
Minimum
Maximum
Spot

Confirm the settings match your requirements and tap on the Accept button.

BASIC		TRIGGERS (0)	
User level: Advanced			
Input Sensor	SonicSens Measure		
Sensor Type	Depth		
Input Multiplier	1		
Offset	0		
Recording Unit	mm		
Logging Mode	Spot		
ACCEPT		CANCEL	



A channel summary will appear amongst other channels on the “Channels” page.

5	SonicSens Measure - Depth (mm) Multiplier: 1 - Spot
---	--

**Note:** The logger is now set to obtain numeric measurement data from the SonicSens3 sensor, but these are **not yet suitable** for being logged:

- The sensor must be set to use a profile suitable for the installation site. This includes setup for sensor range and echo response threshold. (These should be set following the sensor being mounted in position).
- Further setup is also required regarding how to handle the raw data from the sensor to produce datapoints for logging. (Refer to section 16 for further information).

## 14.2 MEASUREMENT QUALITY (OF DISTANCE) MONITORING

The SonicSens3 includes the ability to provide an indication of the measurement quality of distance measurements. This may be set up as another channel and used for monitoring purposes.

If required, add another new channel, and then repeat the setup process (in a similar manner to that described in section 14.1) for obtaining a means of monitoring the quality of the ultrasonic distance measurements. This is a measure derived (a rolling average) from the number of “good” and “bad” measurements that are obtained from the measurement system of SonicSens 3.

For this, select an Input Sensor of “SSense Qual”.

<b>Input Sensor</b>
BAT-V
⋮
Pressure4
SonicSens Measure
<b>SonicSens Qual</b>
SonicSens Temp

BASIC	TRIGGERS (0)
User level: Advanced	
Input Sensor	<Disabled>
Sensor Type	
Recording Unit	
Logging Mode	Off

Select the other settings as shown opposite.

Then tap on "Accept".

BASIC		TRIGGERS (0)
User level: Advanced		
Input Sensor	SonicSens Qual	
Sensor Type	Quality	
Input Multiplier	1	
Recording Unit	%	
Logging Mode	Spot	

ACCEPT CANCEL

The channel will be added to the list of those being logged.

8 SonicSens Qual - Quality (%)  
Multiplier: 1 - Spot

(An example of use may be the remote monitoring of the SonicSens3 installation).

## 14.3 AMBIENT TEMPERATURE

If required, add another new channel and then repeat the setup process (in a similar manner to that described in section 14.1) for obtaining the ambient temperature. This is obtained from a temperature measurement sensor inside the SonicSens3 unit.

An example of the final settings are shown opposite.

(No Input multiplier option is available; IDT automatically sets this for this sensor based on other settings).

Confirm the settings and tap on the Accept button.

The screenshot shows a configuration screen with a blue header containing a gear icon and a right-pointing arrow. Below the header are two tabs: 'BASIC' and 'TRIGGERS (0)'. The 'BASIC' tab is selected. Below the tabs, the text 'User level: Advanced' is displayed. The main content area contains several rows of settings:

Input Sensor	SonicSens Temp
Sensor Type	Temperature
Offset	0
Recording Unit	°C
Logging Mode	Spot

At the bottom of the screen are two blue buttons: 'ACCEPT' and 'CANCEL'.

Note: The logger is now set to obtain ambient temperature measurement data from the SonicSens3 sensor. These readings are used directly as datapoints and logged.

A channel summary will appear amongst other channels on the "Channels" page.

The screenshot shows a channel summary entry with a blue border. It contains the following text:

6 SonicSens Temp - Temperature (°C)  
Multiplier: 0.1 - Spot

## 15 IDT(APP) INSTALLATION OF SONICSENS 3

Following an initial check that the SonicSens3 is operational (see section 13), the unit can be mounted in its installation position. Refer to section 5.3 for details.

SonicSens3 can be set to measure distance to the surface of, or depth of, a water channel.

## 16 IDT(APP) SETUP OF BASIC MEASUREMENTS FROM SONICSENS3

Following setup of the logger to be able to read distance measurements from SonicSens3 (as described in section 14.1), a new configuration option (called “SonicSens Configuration”) appears in the IDT Configure Device screen:

From the main options screen, tap on Configure Device.

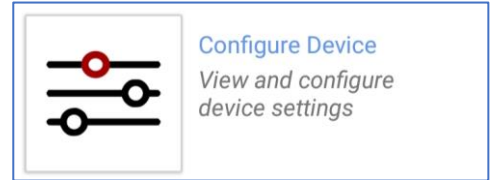

Then tap on “SonicSens Configuration”.  
(You must have a SonicSens 3 connected to the logger).

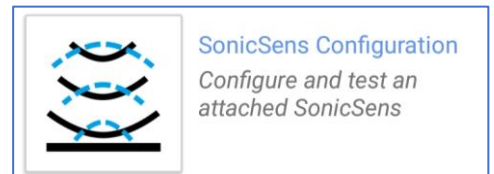

This screen is used to set up additional settings for each SonicSens3 attached to the logger.

If more than one SonicSens3 unit is fitted, tap on the “SonicSens Sensor” line to switch between the sensors. The page will refresh to show the current settings for the selected interface.

The top line gives details of which version (maximum ultrasound range) of sensor is connected to the selected channel.

Before proceeding any further, check the length of the cable and then set the cable length setting in IDT.  
(This control is only available for certain loggers. It affects comms speed between logger and sensor. If shown, it must be set for correct sensor operation).

Cable length
1 metre
5 metres
10 metres
20 metres
30 metres

**SonicSens Configuration**  
User level: Advanced

Connected Sensor: Standard - 10000mm (50kHz)

SonicSens Sensor SonicSens Measure

Measurement Mode Distance

Lost Echo Value Use substitute value

Lost Echo Substitute Value 1234

Temperature Override (°C) Not set

Range Extra short

Threshold Standard

Cable length 5 metres

Note: The installer should adjust settings:

- First, set the logger for making the required distance measurement (see sections 16.1, 16.2).
- Next, the profile of the ultrasound measurement system (i.e. Range and Threshold) should be checked and modified as required (see section 16.3).
- Repeat the above for each SonicSens3 sensor.

## 16.1 MEASUREMENT OF DISTANCE

SonicSens can directly measure distance. This is the distance,  $d$ , between the lower part of the sensor and the surface of the water, shown opposite.

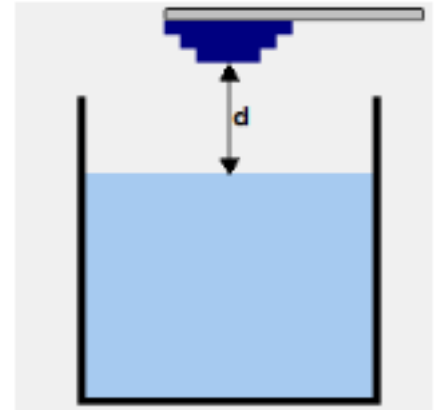

When setting up the SonicSens configuration, choose "Distance" for distance measurements.

Measurement Mode
Depth
<b>Distance</b>

SonicSens Configuration	
User level: Advanced	
Connected Sensor: Standard - 10000mm (50kHz)	
Measurement Mode	<b>Distance</b>

If the water surface is "choppy", it could result in a temporary condition of the ultrasound pulses not being reflected towards the sensor head). The logger calls this situation a "lost echo" condition. Without data substitution, the data-stream could include random "garbage" results.

Two options exist for data substitution on the occurrence of a lost echo.

Either the last valid value can be used, or a user defined fixed value can be used. Set the required data substitution method.

Either select "Use Last Value"

Lost Echo Value
<b>Use last value</b>
Use substitute value

Measurement Mode	Distance
Lost Echo Value	Use last value

... or select  
"Use substitute  
value".

The screenshot shows a configuration menu with three items: 'Lost Echo Value' (with options 'Use last value' and 'Use substitute value'), 'Lost Echo Substitute Value' (with a value of '0'), and 'Measurement Mode' (with a value of 'Distance'). The 'Lost Echo Value' option is highlighted with a dashed yellow box.

Lost Echo Value	Use last value
Lost Echo Value	Use substitute value
Lost Echo Substitute Value	0
Measurement Mode	Distance
Lost Echo Value	Use substitute value
Lost Echo Substitute Value	0

### **Initial temperature substitution**

There is an additional step that may be required during initial installation:

The SonicSens 3 is built with a protective resin inside and therefore an internal temperature sensor within the unit can take several minutes to adjust to the ambient temperature. If the unit has just come out of cold storage or a hot vehicle, the temperature readings will initially not reflect ambient temperature, and will cause a slight inaccuracy in distance measurements (the sensor attempts to compensate for variations in the speed of sound due to air temperature).

There is a facility to temporarily (approximately 60 minutes) override the internal sensor and apply a temperature manually entered.

Tap the  
"Temperature  
Override (°C)"  
line and then enter  
the ambient air  
temperature (°C).

The screenshot shows a dialog box titled 'SonicSens3 temperature override' with 'CANCEL' and 'OK' buttons. To its right is a configuration menu with three items: 'Measurement Mode' (Distance), 'Lost Echo Value' (Use last value), and 'Temperature Override (°C)' (Not set).

SonicSens3 temperature override	CANCEL	OK
Measurement Mode	Distance	
Lost Echo Value	Use last value	
Temperature Override (°C)	Not set	

The logger will temporarily use the entered temperature, whilst the sensor temperature settles to the ambient.

Note: Setting the temperature override is not required for most installations. After a short interval the sensor will be at ambient temperature.

When finished, accept the settings by leaving the configuration screen. *Proceed to section 16.3 to continue setup.*

## 16.2 MEASUREMENT OF DEPTH

SonicSens can indirectly measure water depth.

This is the distance,  $d$ , between the lower part of the water channel and the surface of the water, shown opposite.

This is related to the measurement from the lower part of the sensor and the surface of the water (see section 16.1), and can be calculated as long as the distance 'h' is known.

(It is required to measure "h" on site after final positioning of the sensor).

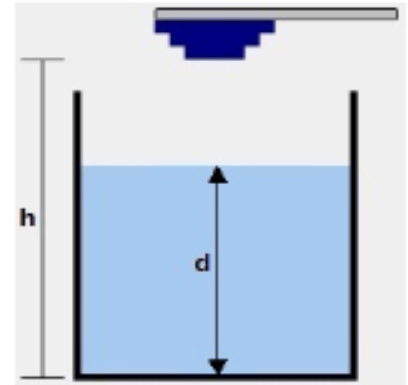

When setting up the SonicSens Configuration, choose a Measurement Mode of "Depth" for depth measurements.

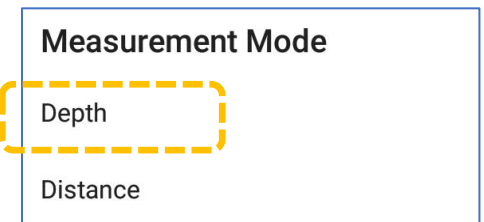

Tap on "Depth (to bottom of chamber)".

Measure the distance from the bottom of the sensor to the bottom of the water channel, in mm; Enter this distance in the dialogue box.

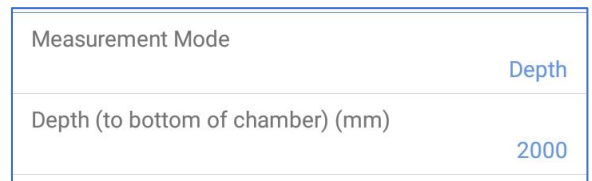

Enter any remaining setup values (see section 16.1 for guidance) and, if required, set the temperature override if this is a new installation.

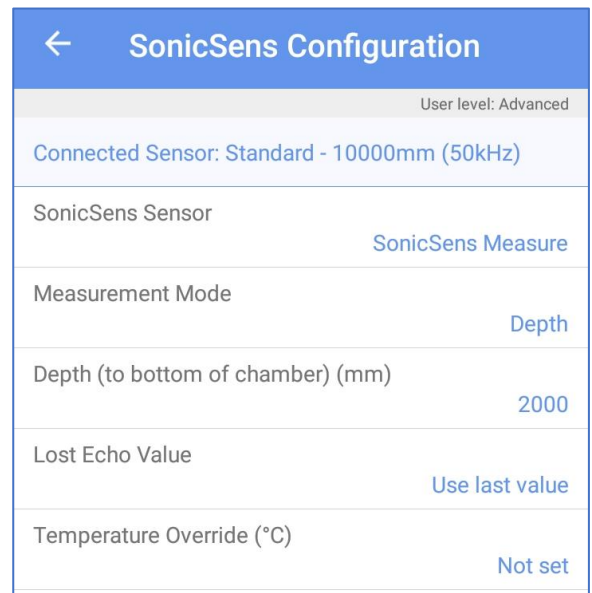

When finished, accept the settings by leaving the configuration screen.  
*Proceed to section 16.3 to continue setup.*

## 16.3 SONICSENS 3 PROFILE SETUP (RANGE AND THRESHOLD ADJUSTMENT)

### 16.3.1 Range adjustment

Access the SonicSens Configuration screen, as described earlier.

The SonicSens 3 sensor has a minimum and maximum range, along with a dead-bands that are too close to and too far from the sensor, as described in section 3.

The logger can adjust the sensor to give more accurate readings if it is set to the required range profile. This also affects the dead-band positions.

The range of the unit can be adjusted by tapping on the Range line.

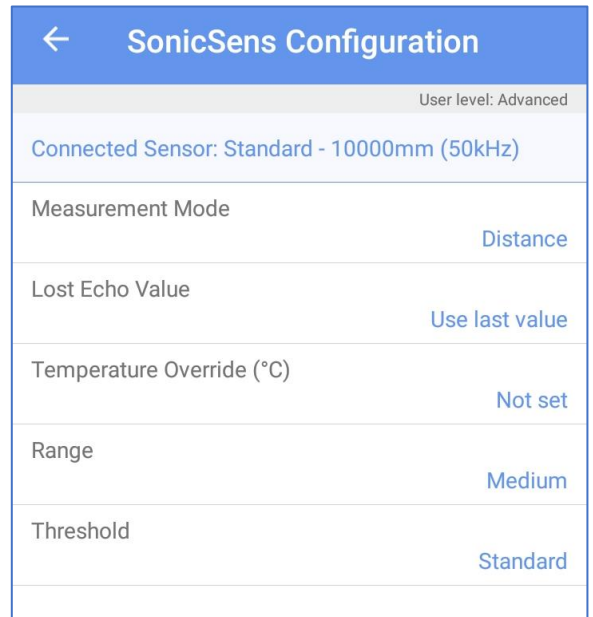

SonicSens Configuration	
User level: Advanced	
Connected Sensor: Standard - 10000mm (50kHz)	
Measurement Mode	Distance
Lost Echo Value	Use last value
Temperature Override (°C)	Not set
Range	Medium
Threshold	Standard

A set of standard range profiles is available for ultrasound distance measurements.

The approximate maximum range of each profile is shown below:

- Extra Short up to 1,400mm.
- Short up to 3,200mm.
- Medium up to 7,500mm.
- Long up to 10,000mm.

#### Range

Extra short

Short

Medium

Long

Select the most appropriate profile option for the installation.

The “most appropriate” selection depends on the expected range of water levels.

- Measure from the lowest part of the sensor to the bottom of the water channel; This will effectively give you the maximum distance that needs to be measured.
- Measure from the lowest part of the sensor to the highest expected water level; This will effectively give you the minimum distance that needs to be measured.
- Ensure the sensor has sufficient spacing from the maximum water level to not encroach on the dead-band region. Re-position the sensor if required and check the range profile again.

Having chosen the appropriate standard profile, **which should be OK for most installations**, the reliability of the sensor detecting the water-level from the echo response can now be checked (see section 16.3.2).



If the water channel is currently empty, IDT has an Auto-range button that can be used. This sets the unit to the shortest possible range, based on the current measurement. However, if a high level of water is present in the channel there is a risk that the range may not be adequate to measure correctly at lower water levels.

Therefore, when using auto-range also check the selected profile is going to be suitable for use when the water is at its minimum level.

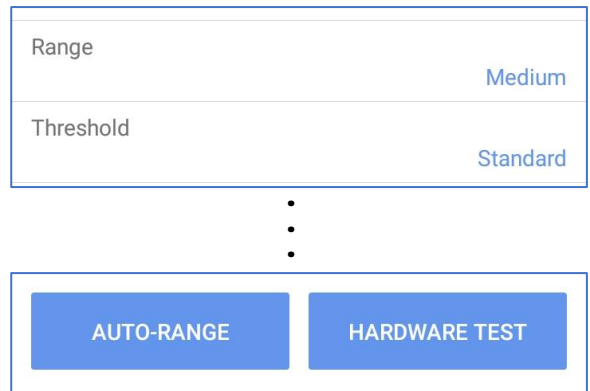

### 16.3.2 Echo Check / Threshold adjustments

The SonicSens 3 settings can be tuned to the local conditions of the installation:

Tap on the Threshold line.

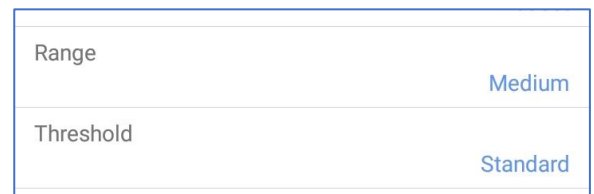

A new graphical screen (called “Calibration”) will appear, which shows more detail of the ultrasound measurement parameters (expectations) and echo measurement results.

It includes:

- The last echo result (shown in blue).
- Near-sensor dead-band (shown in light brown).
- Far-sensor dead-band (the area beyond the blue line).
- The threshold limits (red line and dots) for an echo to be accepted as valid.
- The echo (spike) that has been judged as a valid result (a green vertical bar). It is positioned where the echo response (blue trace) first crosses the threshold line. It is normally the earliest echo received; this corresponds to the echo which takes the shortest path.
- Additional echoes (spikes in the blue trace) may be present later in the trace. These usually come from sound that has bounced off the chamber walls and so take a longer path.

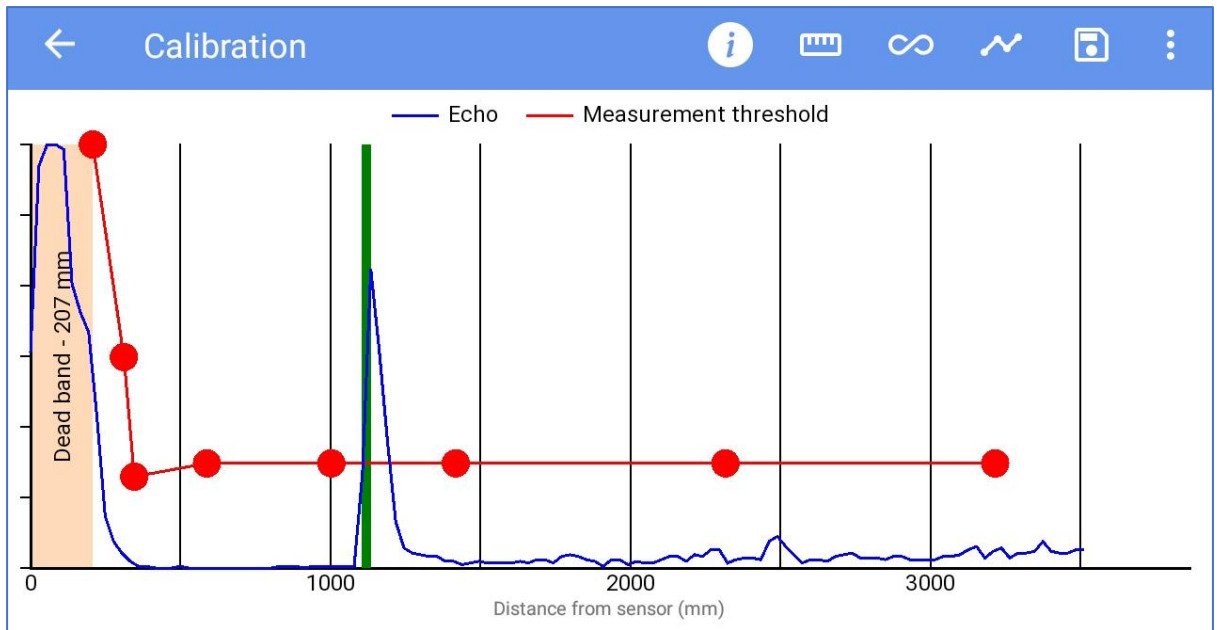

Note: Controls on the Calibration screen are detailed below:

The "Measure" button makes a single new measurement.

The "Continuous Measure" button repeatedly makes new measurements at regular intervals.

The "Reload values" button resets any adjustments back to the standard profile.

The "Save" button saves the existing profile (including threshold adjustments) for use.  
(The standard settings remain for later use if required).

The "Information" button loads a help-screen.

The "Menu" button will show a local menu with guidance.

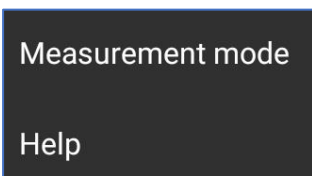
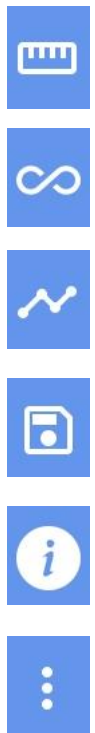

Local Menu (example)

**Help**

- Dragging the first node on the left further to the right will enlarge the dead band; to reset it, a new range profile must be loaded.
- Nodes cannot be dragged into the dead band on the left or the depth band on the right (if one exists) and can't overlap each other horizontally.
- Nodes cannot be more than 1 metre apart and will move automatically if its left neighbour is moved more than 1 metre away.

OK

Help screen (example)

If the logger has been set to measure depth rather than distance, IDT will indicate the depth of the chamber by a red region superimposed over the normal sensor range.

Any echo response that is “further away” than the distance between the sensor and the floor is an invalid result. It has come from an indirect path (e.g., it has bounced off the side wall of the chamber).

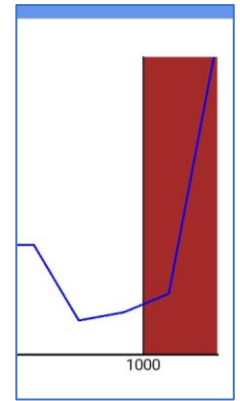

### **Echo Check / Threshold adjustments**

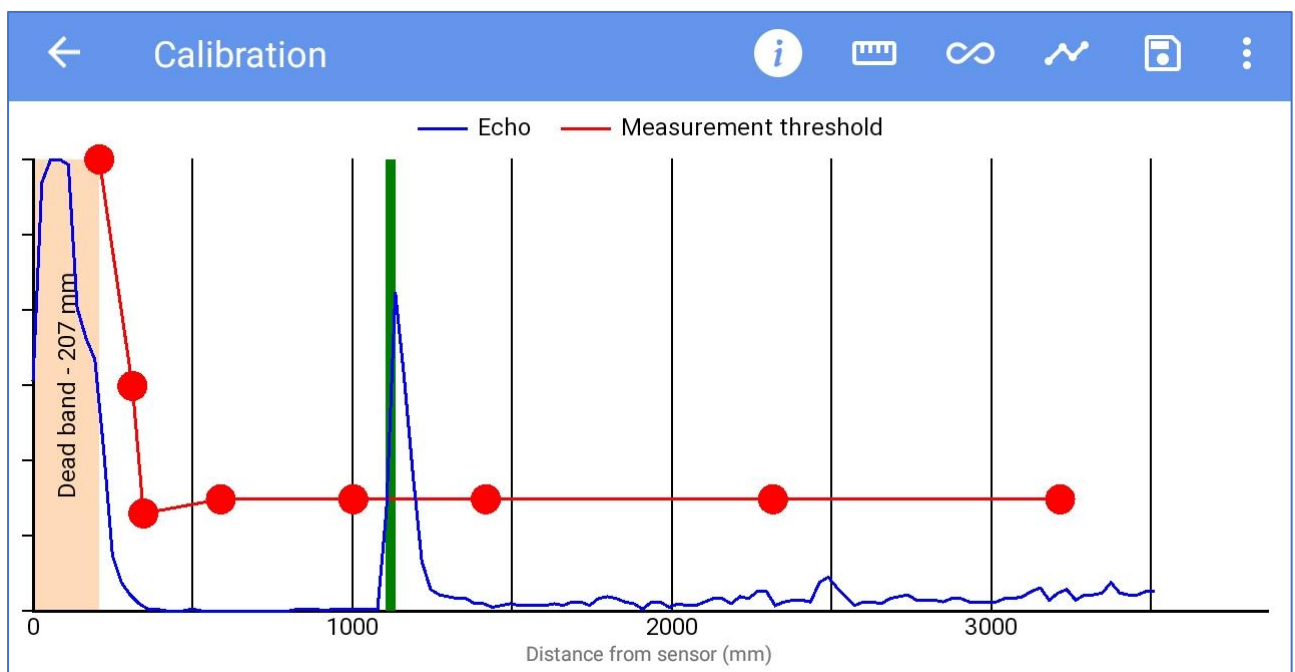

An example of a good echo response is shown above (blue). There is one distinct peak (spike). The peak is well above the threshold line (red). Other echoes are well below the threshold line, almost at the “noise floor” in the trace above. These smaller peaks represent the echoes that have taken alternative paths to return to the sensor

The threshold line is shown on the graph as a line that travels from left to right on the display, joining together a series of red dots. The threshold can be adjusted by moving the position of the dots, but IDT follows certain constraints when making the adjustments:

- The threshold line always moves progressively right and cannot double-back on itself (no overlaps).
- The threshold cannot be moved into the dead-band (on the left) or the maximum depth indication (on the right, if it exists).
- Nodes cannot be more than 1 meter apart.

For most situations, loading one of the profiles from the menu gives good results, and no further adjustments are needed. However, adjustment should be made under the following circumstances:

- When the threshold is too high (echo is weak and risks not being detected) ; lower the threshold.
- When the noise-floor is high (which could lead to measurement errors) ; raise the threshold.
- When some additional echo is visible due to the presence of a fixed object in the chamber (e.g., a cable or an access ladder) ; move the threshold to a higher position where this nuisance echo occurs. However, if the nuisance echo is as strong as the water surface echo, try to remove or re-locate the offending feature. Alternatively, re-locate the sensor to a more suitable location.

e.g. In the example opposite, a nuisance echo is present at 3.5m, but the valid echo is at 4.6m. The solution is to raise the threshold by moving the dot near the nuisance echo slightly up. This will result in the nuisance echo being ignored and the valid echo being chosen.

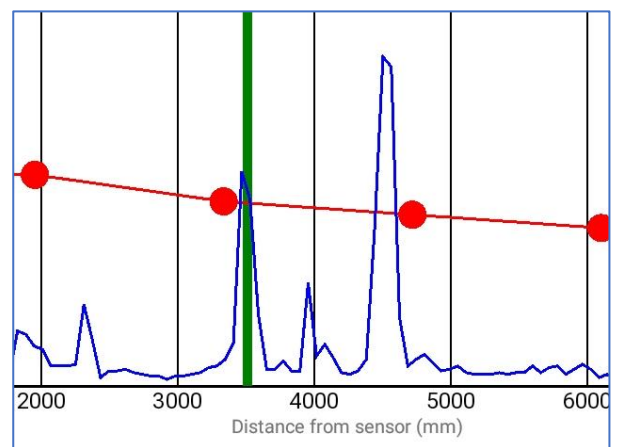

Caution is required when making adjustments, since it could introduce an additional dead-band for the sensor where measurements cannot be made. Any changes made should be minimal.

Following adjustment, re-test the echo response using the Measure or Continuous Measure buttons. Ensure the logger is locating the water-surface echo correctly and identifying it with a green line on the display. Confirm the reliability of the measurement before proceeding.



When the results are acceptable, click on the Save button to store them in the logger.



## 17 IDT(APP) SETUP OF ADDITIONAL MEASUREMENTS

If the feature is available on your logger, the following measurements (derived from water depth) can be added:

- Flow of water from a Weir (V-Notch).
- Flow of water from a Weir (Rectangular).
- Flow of water from a Weir (Constricted Rectangular).
- Flow of water through an open channel with known depth to flow characteristics.

### 17.1 FLOW OF WATER FROM A WEIR

The SonicSens 3 can be used to (indirectly) measure the water flowing from a weir.

This requires a SonicSens *depth measurements* to be used as the input to a different channel, known as an “Open Channel Flow” type of channel.

(In the IDT app this is called a “FlowOCH” type of channel).

From the main options screen, tap on Configure Device.

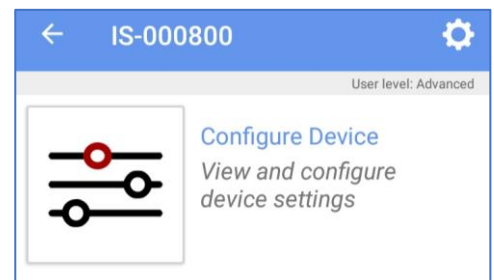

A new options selection page will appear.

Tap on “Channels”.

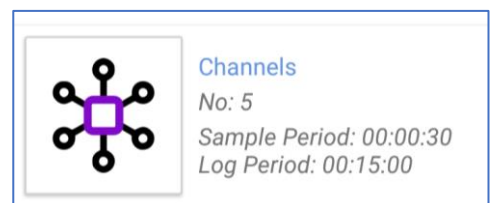

If the logger has not been set up for FlowOCH measurements, tap on the “+” control to add a new channel.



Tap on the Input Sensor line.

(This normally selects the interface type, but here the required ‘interface’ is a software connection to another channel from which it can use the data).

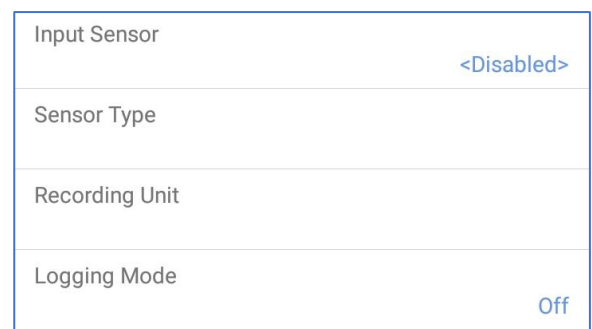

Choose "FlowOCH".

**Input Sensor**

BAT-V

FlowOCH

SpillSens1

CANCEL

BASIC ADVANCED TRIGGERS (0)

User level: Advanced

Input Sensor FlowOCH

Sensor Type

Recording Unit

Logging Mode Average

Select the Sensor Type as "Flow"

**Sensor Type**

Flow

Select the desired recording unit.

**Recording Unit**

l

m<sup>3</sup>

gal

ML

CuFt

... and also set a Logging mode.

BASIC ADVANCED TRIGGERS (0)

User level: Advanced

Input Sensor FlowOCH

Sensor Type Flow

Recording Unit l

Logging Mode Spot

Switch to the "ADVANCED" tab.

Tap on the "Conversion table type" line.

**Conversion table type**

Depth/Flow

Depth/Flow (Weir)

CANCEL

Select "Depth/Flow (Weir)".

BASIC ADVANCED TRIGGERS (0)

User level: Advanced

Conversion table type Depth/Flow (Weir)

Depth Channel 5 SonicSens Measure

Chamber Depth (mm) 2000

EDIT

Tap on the "Depth Channel" line to select the sensor channel from which data is being used.

(The selected sensor must have been already set up to detect **Depth** of Water , and not the distance to the water surface). The depth of the chamber (distance from the sensor

to the bottom of the water channel) is also shown in this screen for ease of adjustment. Confirm and adjust if required.

Tap on the Edit button, or if it is absent, the “ + ” line; this will show an additional setup screen, called the “Depth / Flow (Weir)” screen.

This channel requires the geometry of the weir to be entered. The logger then converts the depth of water (provided by SonicSens3) into an expected rate of flow from the weir.

Note: When describing the weir features, all dimensions are to be taken from **inside the water channel**, not from the external side. The weir blocks the flow of water until its depth exceeds the minimum height of the weir, known as the “crest”.

**For a rectangular weir:**

Tap on Weir Type and select “Rectangular”.

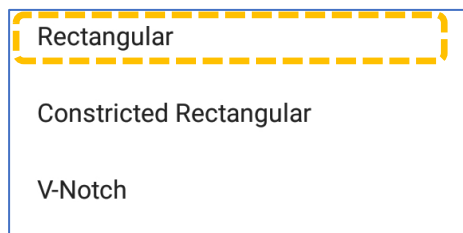

Measure the features of the weir and complete the settings in the setup screen.

Then tap on “Accept”.

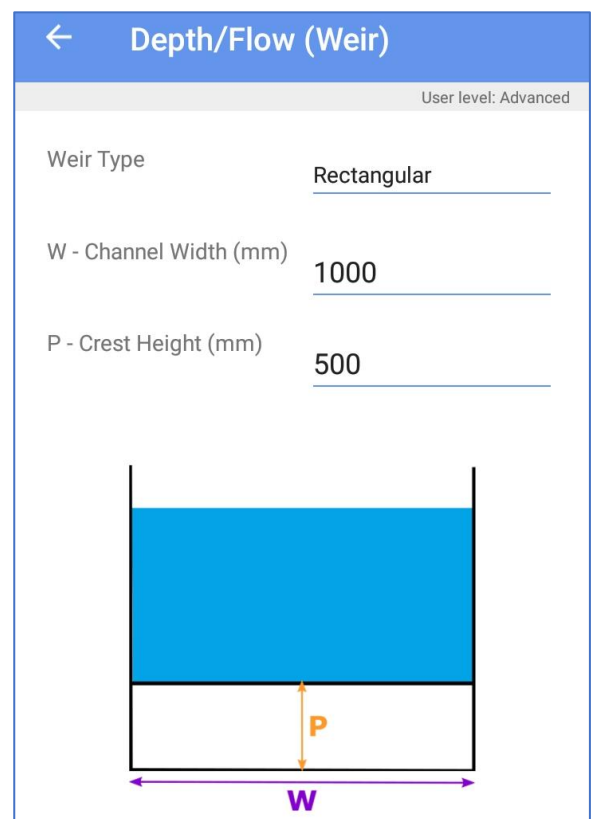
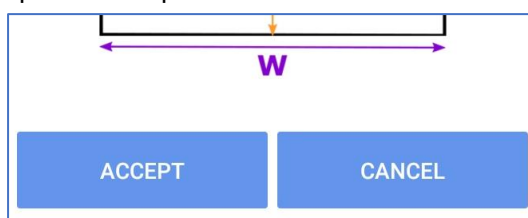

**For a constricted rectangular weir:**

Tap on Weir Type and select "Constricted Rectangular".

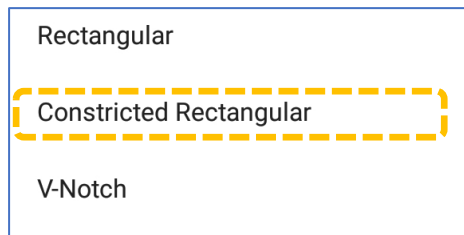

Measure the features of the weir and complete the settings in the setup screen.

Then tap on "Accept".

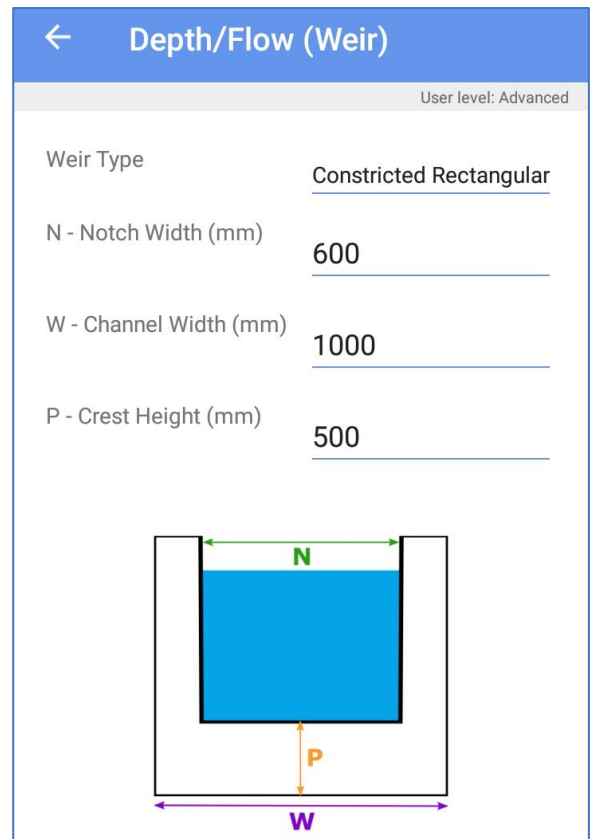
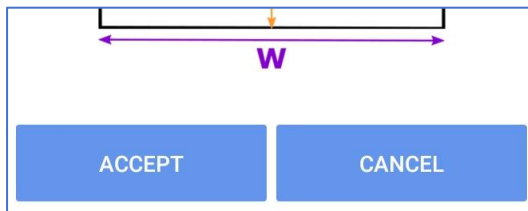

**For a V-notch weir:**

Tap on Weir Type and select "V-notch".

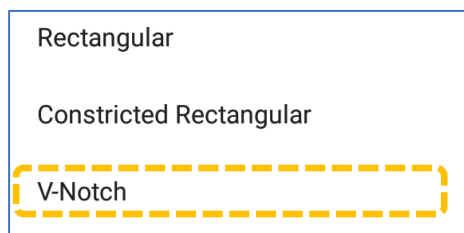

Measure the features of the weir and complete the settings in the setup screen.

Then tap on "Accept".

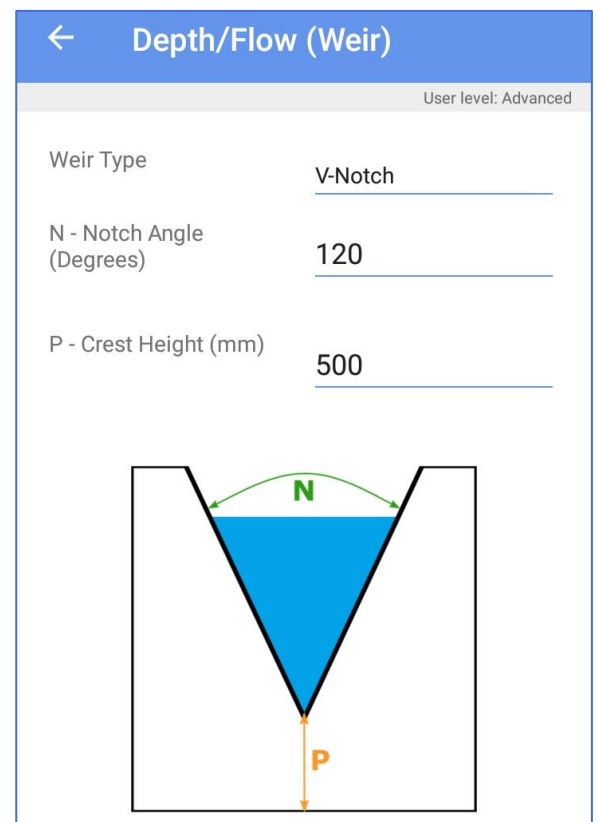
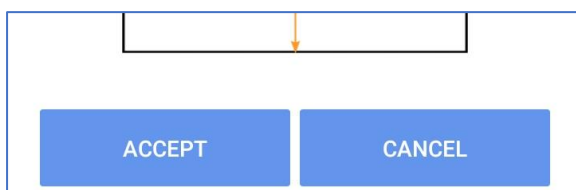



After accepting the setup, IDT will display the FlowOCH channel amongst the list of currently configured channels (each channel will produce datapoints that are logged).

The FlowOCH summary includes selected units of measure for flow and any statistical function applied to produce the datapoints. (e.g., Average).

(The “units/pulse” figure has no meaning).

Logged Channels	
1	SSense Measure - Depth (mm) Multiplier: 1 - Spot
2	SSense Temp - Temperature (°C) Multiplier: 0.1 - Spot
3	Flow Uni 1.1 - Flow (m³) Units/Pulse: 1 - Spot
4	SpillSens1 - Angle (°) Multiplier: 1 - Spot
5	Flow Uni 1.2 - Flow (m³) Units/Pulse: 1 - Spot
6	FlowOCH - Flow (l/s) Units/Pulse: 0.01 - Average

Note: For a weir of a different shape to the above options, but where the “depth to flow” characteristics are known, they can be entered in tabular form. (Refer to section 17.2).

## 17.2 FLOW OF WATER THROUGH AN OPEN CHANNEL

For any water channel which has “depth to flow” characteristics that are known, flow can be measured indirectly by using depth. The characteristics must be entered in tabular form.

Proceed with setup as per section 17.1, until the Advanced tab is selected. Then proceed as follows:

Switch to the “ADVANCED” tab of the channel setup screen.

Tap on the “Depth Channel” line to select the sensor channel from which data is being used. The selected sensor must have been already set up to detect Depth of Water (not distance to water surface).

Note: Distance to water surface could also be used, but the table would have to be adapted to suit.

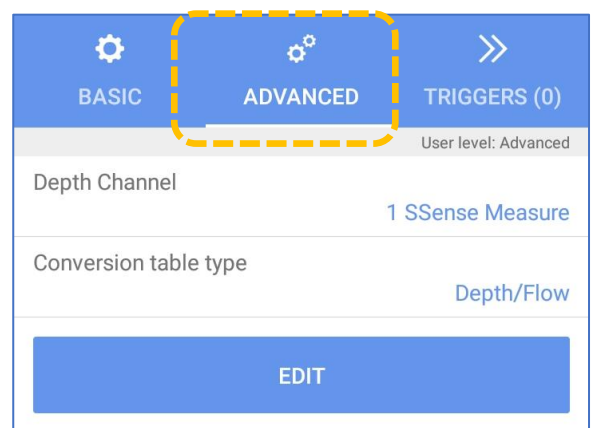

Tap on the “Conversion table type” line.

Select “Depth/Flow”.

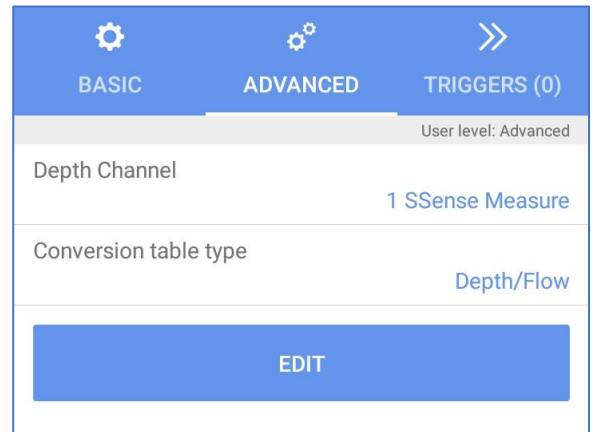
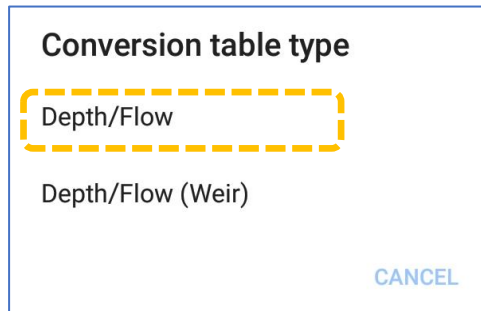

Tap on the Edit button, or if it is absent, the “+” line; this will show an additional setup screen, called the “Depth / Flow” screen.

This channel requires the Depth to Flow characteristics of the water channel to be entered in table form.

The logger uses the table to convert the depth of water (provided by SonicSens3) into an expected rate of flow rate through the channel.

Note: The logger interpolates between the table entries to give a good approximation to the rate of flow at depths between table values.

Note: Where flow does not start until a specific depth of water is present (e.g. the crest of a weir will block the flow of water at low levels), two levels of “0” flow rate are needed; First at a depth of “0”, and second at the crest of the obstacle.

Complete the table. Then tap on “Accept”.

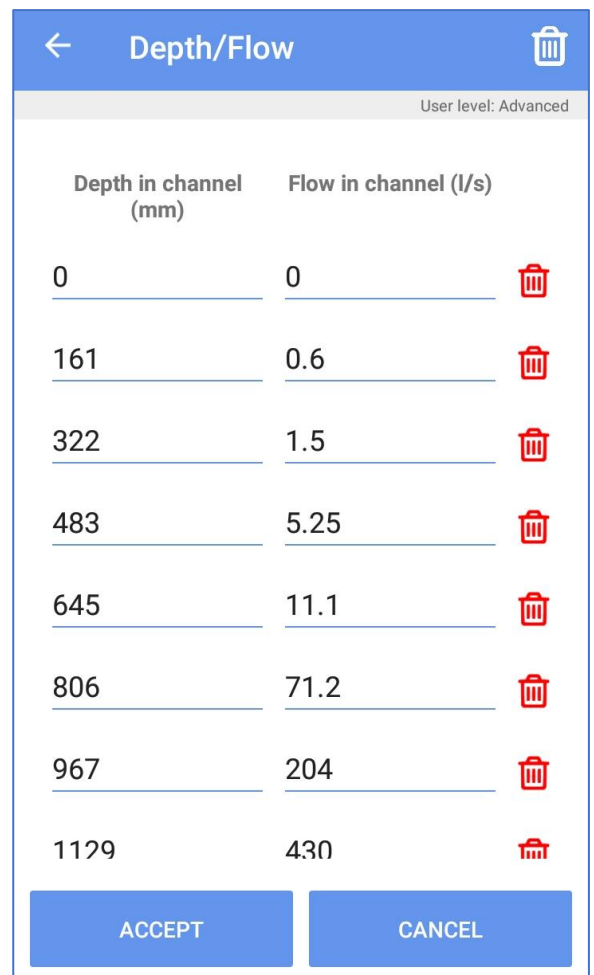

## 18 IDT(APP) SETUP OF ALARMS

---

Measurement results that are logged can be checked for a variety of conditions that should cause an alarm. Setup of and monitoring for an alarm condition is a general logger function, not specific to SonicSens 3.

Consult the IDT manual for how to setup an alarm condition on a channel.

## 19 USER-SERVICEABLE PARTS

---

SonicSens 3 is a sealed unit and has no user-serviceable parts.

Suspect units can be returned to the HWM service center for investigation or re-calibration upon completing an on-line RMA form (Return Materials Authorization).

<https://www.hwmglobal.com/hwm-rma/>

Ensure the unit is cleaned with a mild cleaning solution and soft brush or brush, disinfected, and dried prior to shipment.

## 20 TROUBLESHOOTING

---

Incorrect measurement:

- Check SonicSens 3 is not contaminated with dirt or debris. Clean using a mild cleaning solution and a soft cloth or brush if required.
- Check the SonicSens 3 is level.
- Check the SonicSens 3 fitted has the correct range.
- Check the SonicSens 3 profile settings being used are suitable.
- Check the SonicSens 3 beam cone has no obstacles.
- Check cable length of sensor and adjust in IDT app if required.
- Where more than one SonicSens3 is fitted, check sensor connections are not swapped.

SonicSens3 not found:

- Check latest version of IDT is being used.
- Check battery voltage of logger is good.
- Check cable between SonicSens 3 and the logger is in an OK condition, with no damage or water ingress.
- Check cable length of sensor and adjust in IDT app if required.



Fluid Conservation Systems  
1960 Old Gatesburg Road  
Suite 150  
State College PA, 16803  
(800) 531-5465  
[www.fluidconservation.com](http://www.fluidconservation.com)

©HWM-Water Limited. This document is the property of HWM-Water Ltd. and must not be copied or disclosed to a third party without the permission of the company. All images, text and designs are protected by international and UK copywrite law and remain the property of HWM-Water. It is against the law to copy or use any of the content from the HWM website or literature without the written consent of HWM-Water. HWM-Water Ltd reserve the right to vary the specification.